

2011 AN112 PARTS DIAGRAM

Carburetor

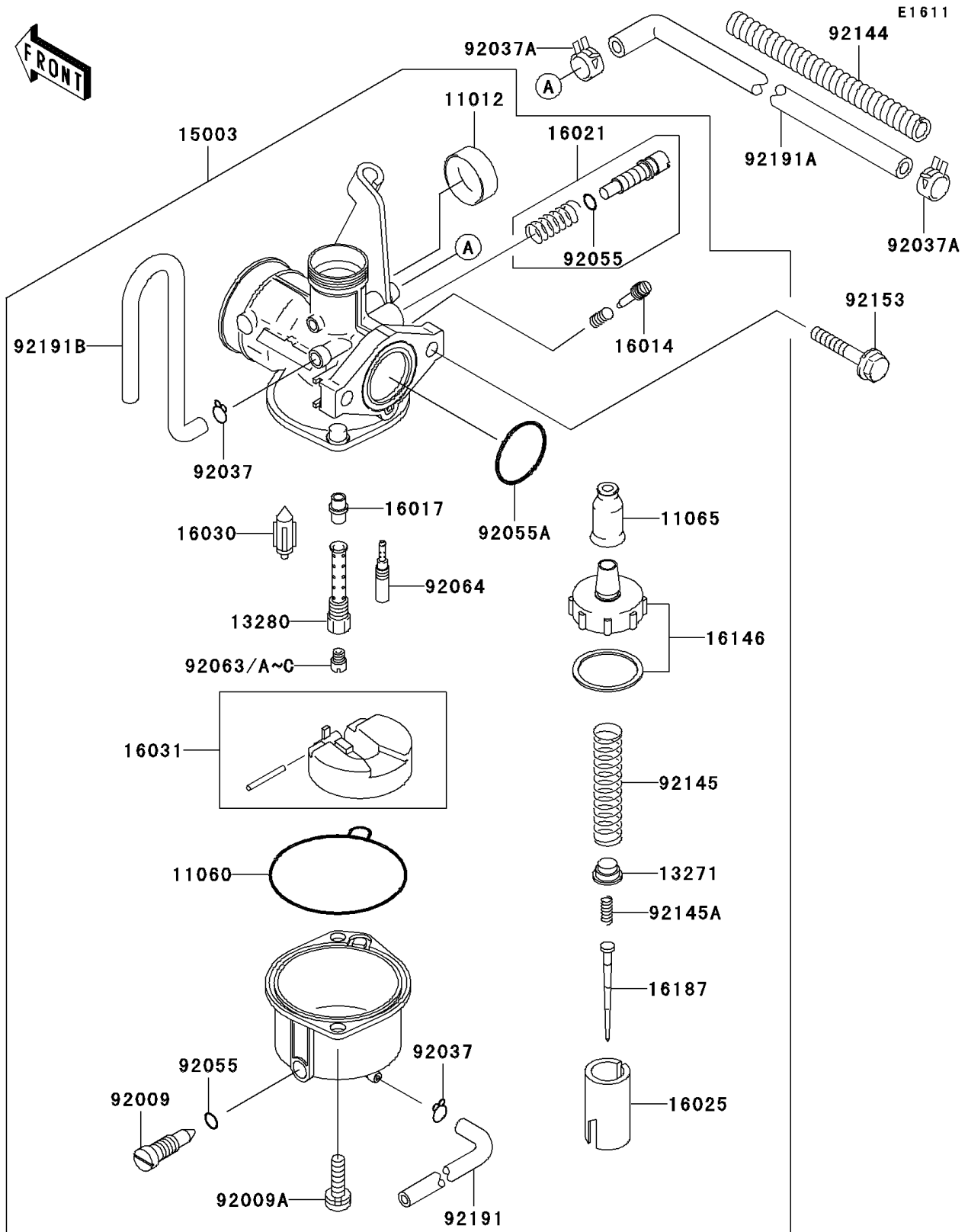

2011 AN112 PARTS LIST

Carburetor

ITEM NAME	PART NUMBER	QUANTITY
CAP,CHOKE (Ref # 11012)	11012-1940	1
GASKET,FLOAT CHAMBER (Ref # 11060)	11060-1700	1
CAP,TOP COVER (Ref # 11065)	11065-1235	1
PLATE (Ref # 13271)	13271-1668	1
HOLDER,NEEDLE JET (Ref # 13280)	13280-1282	1
CARBURETOR-ASSY (Ref # 15003)	15003-1678	1
SCREW-PILOT AIR (Ref # 16014)	16014-1093	1
JET-NEEDLE (Ref # 16017)	16017-1399	1
SCREW-THROTTLE STOP (Ref # 16021)	16021-1203	1
VALVE-THROTTLE (Ref # 16025)	16025-1225	1
VALVE-FLOAT,FLOAT (Ref # 16030)	16030-0002	1
FLOAT (Ref # 16031)	16031-1107	1
COVER-ASSY,CARBURETOR TOP (Ref # 16146)	16146-1229	1
NEEDLE-JET,NANL (Ref # 16187)	16187-1175	1
SCREW,DRAIN (Ref # 92009)	92009-1057	1
SCREW (Ref # 92009A)	92009-1750	2
CLAMP,TUBE (Ref # 92037)	92037-1142	2
CLAMP (Ref # 92037A)	92037-1601	2
RING-O (Ref # 92055)	92055-1053	2
RING-O (Ref # 92055A)	92055-1541	1
JET-MAIN,#78 (Ref # 92063)	92063-1393	1
JET-MAIN,#75 (Ref # 92063A)	92063-1395	1
JET-MAIN,#80 (Ref # 92063B)	92063-1396	1
JET-MAIN,#82 (Ref # 92063C)	92063-1397	1
JET-PILOT,#35 (Ref # 92064)	92064-1204	1
SPRING (Ref # 92144)	92144-1994	1
SPRING,THROTTLE VALVE (Ref # 92145)	92145-1407	1
SPRING,THROTTLE VALVE PLATE (Ref # 92145A)	92145-1408	1
BOLT,FLANGED,6X30 (Ref # 92153)	92153-1187	2

2011 AN112 PARTS LIST

Carburetor

ITEM NAME	PART NUMBER	QUANTITY
TUBE,3.5X6.5X298 (Ref # 92191)	92191-1142	1
TUBE,FUEL (Ref # 92191A)	92191-1204	1
TUBE,3.5X6.5X350 (Ref # 92191B)	92191-1768	1