

2005 Eliminator 125 PARTS DIAGRAM

Cylinder Head

E1111

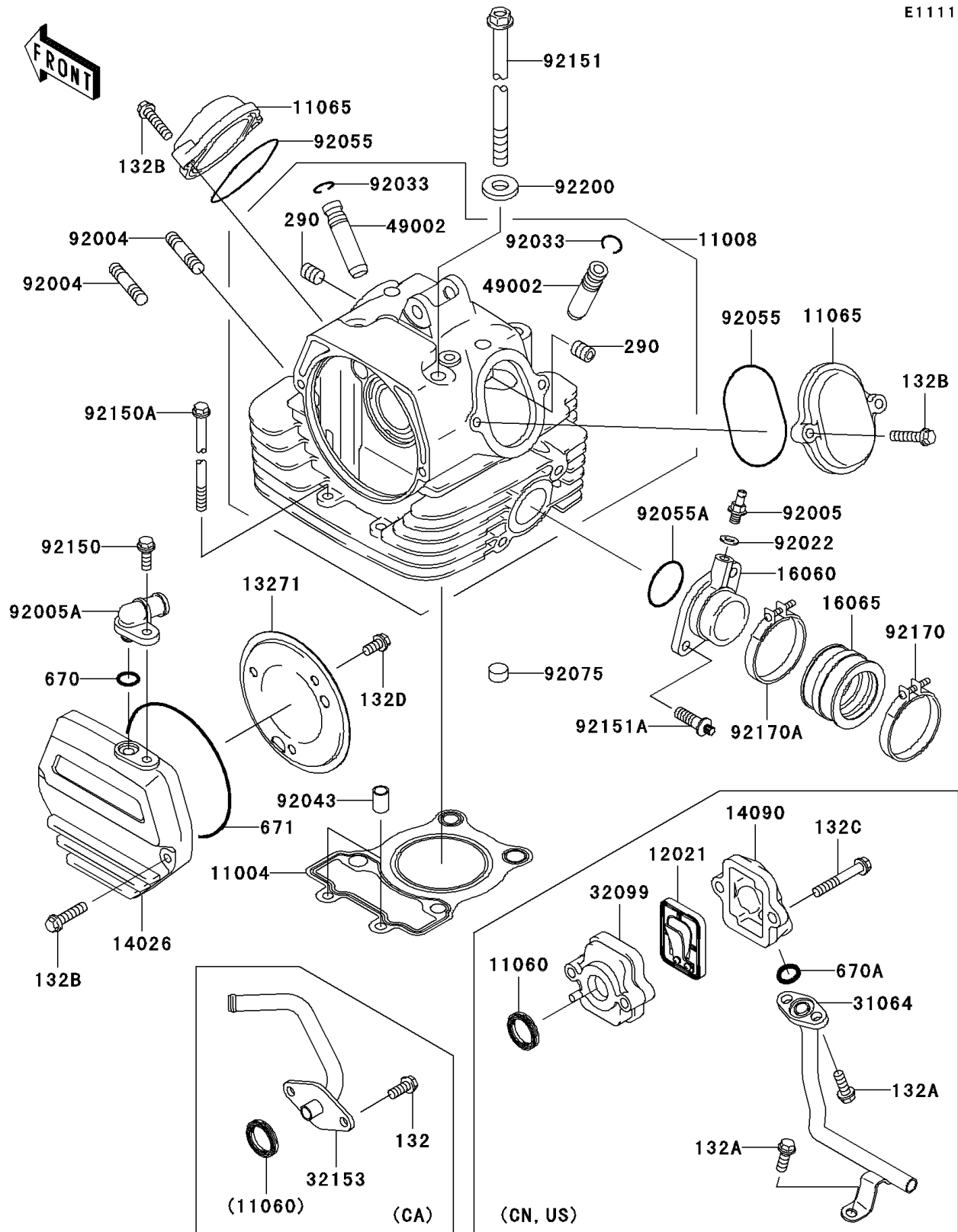

2005 Eliminator 125 PARTS LIST

Cylinder Head

ITEM NAME	PART NUMBER	QUANTITY
BOLT-FLANGED-SMALL (Ref # 132B)	132V0625	6
GASKET-HEAD (Ref # 11004)	11004-1335	1
HEAD-COMP-CYLINDER (Ref # 11008)	11008-1384	1
GASKET, REED VALVE (Ref # 11060)	11060-1815	1
CAP, ROCKER CASE (Ref # 11065)	11065-1071	2
PLATE, BREATHER (Ref # 13271)	13271-1109	1
COVER-CHAIN, CAM SPROCKET (Ref # 14026)	14026-1256	1
PIPE-INTAKE (Ref # 16060)	16060-1084	1
HOLDER-CARBURETOR (Ref # 16065)	16065-1335	1
GUIDE-VALVE (Ref # 49002)	49002-1116	AR
STUD, 8X30 (Ref # 92004)	92004-1121	2
FITTING (Ref # 92005)	92005-1337	1
FITTING, BREATHER (Ref # 92005A)	92005-1342	1
WASHER, 6.1X12X1 (Ref # 92022)	92022-077	1
RING-SNAP (Ref # 92033)	92033-1247	2
PIN, 10.1X12X14 (Ref # 92043)	92043-4009	2
RING-O, 53.5X2.6 (Ref # 92055)	92055-112	2
RING-O, 32MM (Ref # 92055A)	92055-1256	1
DAMPER (Ref # 92075)	92075-1089	17
BOLT, 6X16 (Ref # 92150)	92150-1394	1
BOLT, 6X110 (Ref # 92150A)	92150-1986	2
BOLT, 9X228.5 (Ref # 92151)	92151-1092	4
BOLT, 6X18 (Ref # 92151A)	92151-1726	2
CLAMP, CARBURETOR HOLDER (Ref # 92170)	92170-1094	1
CLAMP, 43MM (Ref # 92170A)	92170-1527	1
WASHER, 9.5X18X1.2 (Ref # 92200)	92200-1037	4
BOLT-FLANGED-SMALL (Ref # 132D)	132Y0612	3
SCREW-SET-SOCKET, 6X6 (Ref # 290)	290Q0606	2
O RING, 10MM (Ref # 670)	670B1510	1

2005 Eliminator 125 PARTS LIST

Cylinder Head

ITEM NAME	PART NUMBER	QUANTITY
O RING (Ref # 671)	671E2595	1
BOLT-FLANGED-SMALL (Ref # 132)	132V0614	2
BOLT-FLANGED-SMALL,6X16 (Ref # 132A)	132V0616	3
BOLT-FLANGED-SMALL (Ref # 132C)	132V0640	2
VALVE-ASSY-REED (Ref # 12021)	12021-1102	1
COVER,REED VALVE (Ref # 14090)	14090-1852	1
PIPE-COMP (Ref # 31064)	31064-1205	1
CASE,REED VALVE (Ref # 32099)	32099-1187	1
PIPE (Ref # 32153)	32153-1560	1
O RING,10MM (Ref # 670A)	670B2010	1