

2011 W800 (European) PARTS DIAGRAM

Starter Motor

E1840

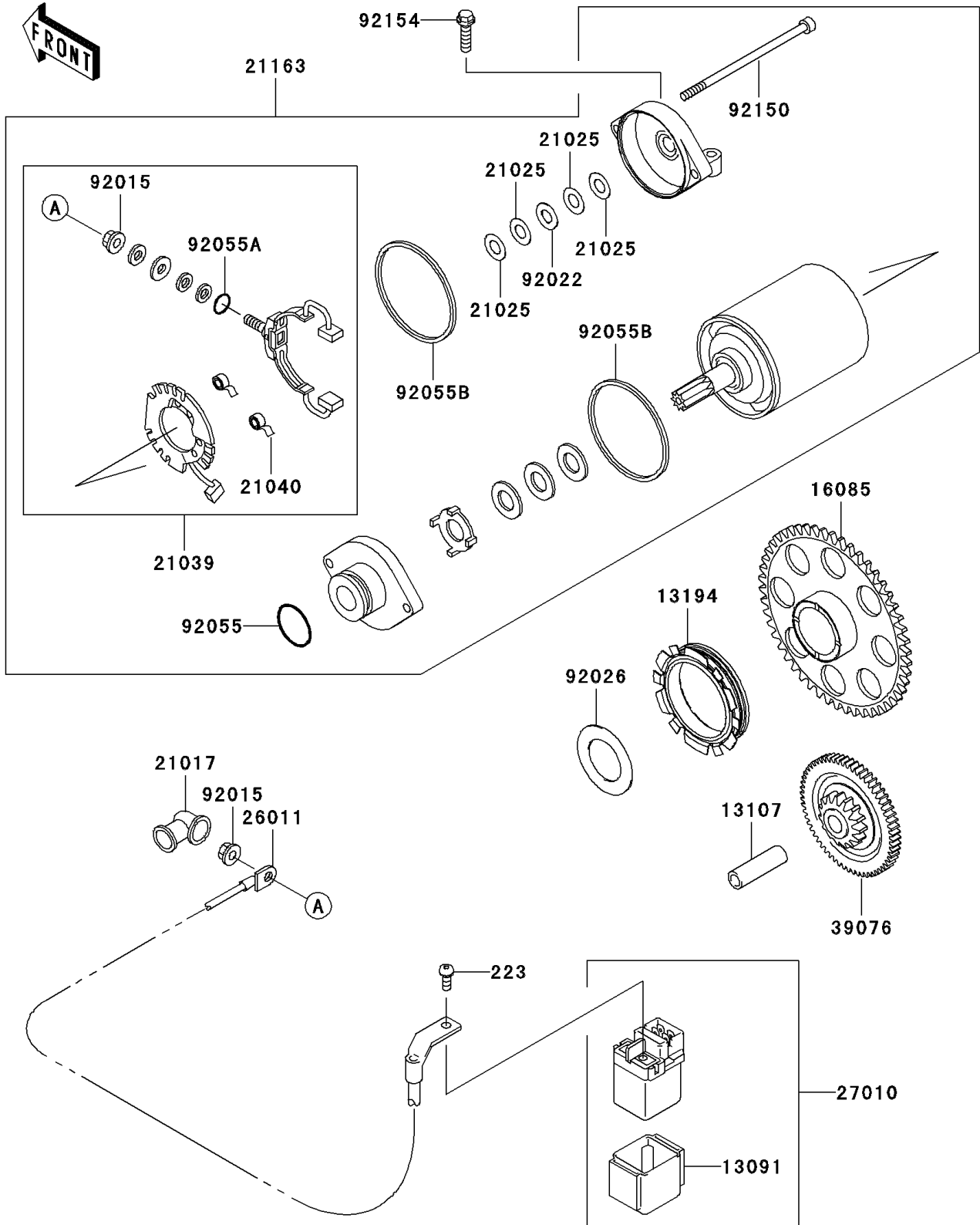

2011 W800 (European) PARTS LIST

Starter Motor

ITEM NAME	PART NUMBER	QUANTITY
SCREW-PAN-WS-CROS,5X10 (Ref # 223)	223AA0510	2
HOLDER,SWITCH (Ref # 13091)	13091-1883	1
SHAFT,IDLE GEAR (Ref # 13107)	13107-1106	1
CLUTCH-ONEWAY (Ref # 13194)	13194-0015	1
GEAR,ONEWAY CLUTCH (Ref # 16085)	16085-1318	1
GROMMET,STARTER TERMINAL (Ref # 21017)	21017-017	1
WASHER,9.1X18X0.2 (Ref # 21025)	21025-011	AR
BRUSH,CARBON (Ref # 21039)	21039-1060	1
SPRING-BRUSH (Ref # 21040)	21040-1055	4
STARTER-ELECTRIC (Ref # 21163)	21163-1263	1
WIRE-LEAD,STARTER MOTOR (Ref # 26011)	26011-1737	1
SWITCH,MAGNETIC (Ref # 27010)	27010-1347	1
LIMITER,STARTER GEAR (Ref # 39076)	39076-1073	1
NUT,STARTER MOTOR (Ref # 92015)	92015-1476	2
WASHER,9.1X18X0.8 (Ref # 92022)	92022-1132	1
SPACER,29.1X47.5X1.2 (Ref # 92026)	92026-087	1
RING-O (Ref # 92055)	92055-1276	1
RING-O,4.5X2.0 (Ref # 92055A)	92055-1370	1
RING-O,STARTER MOTOR (Ref # 92055B)	92055-1381	2
BOLT,STARTER MOTOR (Ref # 92150)	92150-1913	2
BOLT,FLANGED,6X22 (Ref # 92154)	92154-0504	2