

# 1988 Eliminator PARTS DIAGRAM

Engine Cover(s)

E1431-0216

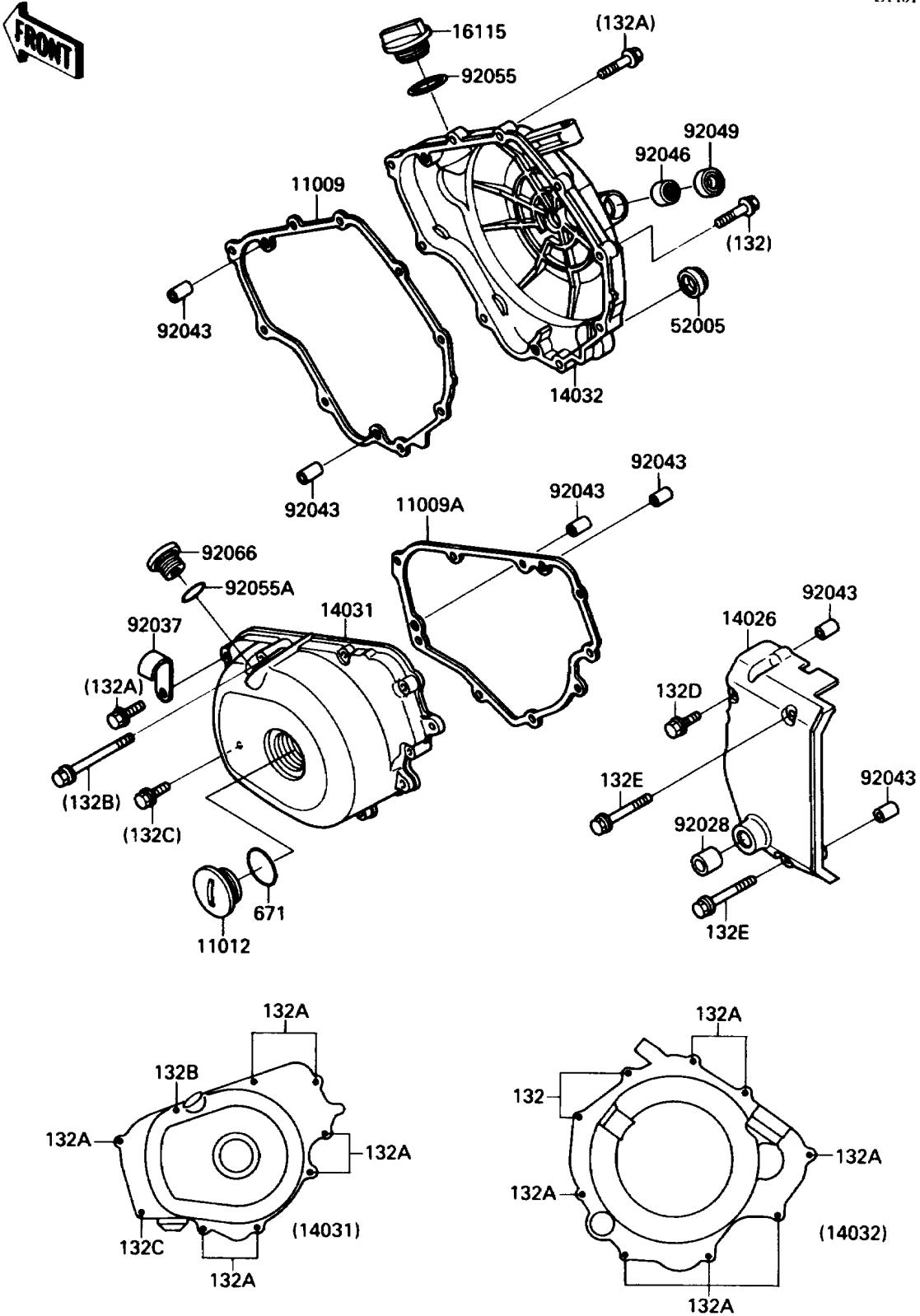

# 1988 Eliminator PARTS LIST

## Engine Cover(s)

ITEM NAME	PART NUMBER	QUANTITY
GASKET,CLUTCH COVER (Ref # 11009)	11009-1569	1
GASKET,GENERATOR COVER (Ref # 11009A)	11009-1570	1
CAP (Ref # 11012)	11012-1616	1
COVER-CHAIN (Ref # 14026)	14026-1132	1
COVER-GENERATOR (Ref # 14031)	14031-1224	1
COVER-CLUTCH (Ref # 14032)	14032-1239	1
CAP-OIL FILLER (Ref # 16115)	16115-1009	1
GAUGE,OIL LEVEL (Ref # 52005)	52005-1009	1
BUSHING (Ref # 92028)	92028-1347	1
CLAMP,WIRING HARNESS (Ref # 92037)	92037-1877	1
PIN,6.2X8X14 (Ref # 92043)	92043-1263	6
BEARING-NEEDLE,HK1210 (Ref # 92046)	92046-1010	1
SEAL-OIL,TB12205.5 (Ref # 92049)	92049-1271	1
RING-O,31.5X2.6 (Ref # 92055)	92055-049	1
RING-O (Ref # 92055A)	92055-1146	1
PLUG (Ref # 92066)	92066-1218	1
BOLT-FLANGED-SMALL (Ref # 132)	132E0625	2
BOLT-FLANGED-SMALL (Ref # 132A)	132E0630	14
BOLT-FLANGED-SMALL (Ref # 132B)	132E0675	1
BOLT-FLANGED-SMALL (Ref # 132C)	132W0630	1
BOLT-FLANGED-SMALL (Ref # 132D)	132W0620	1
BOLT-FLANGED-SMALL (Ref # 132E)	132W0645	2
O RING,40MM (Ref # 671)	671B2540	1