

1988 Eliminator PARTS DIAGRAM

Frame Fittings

F2131-0254

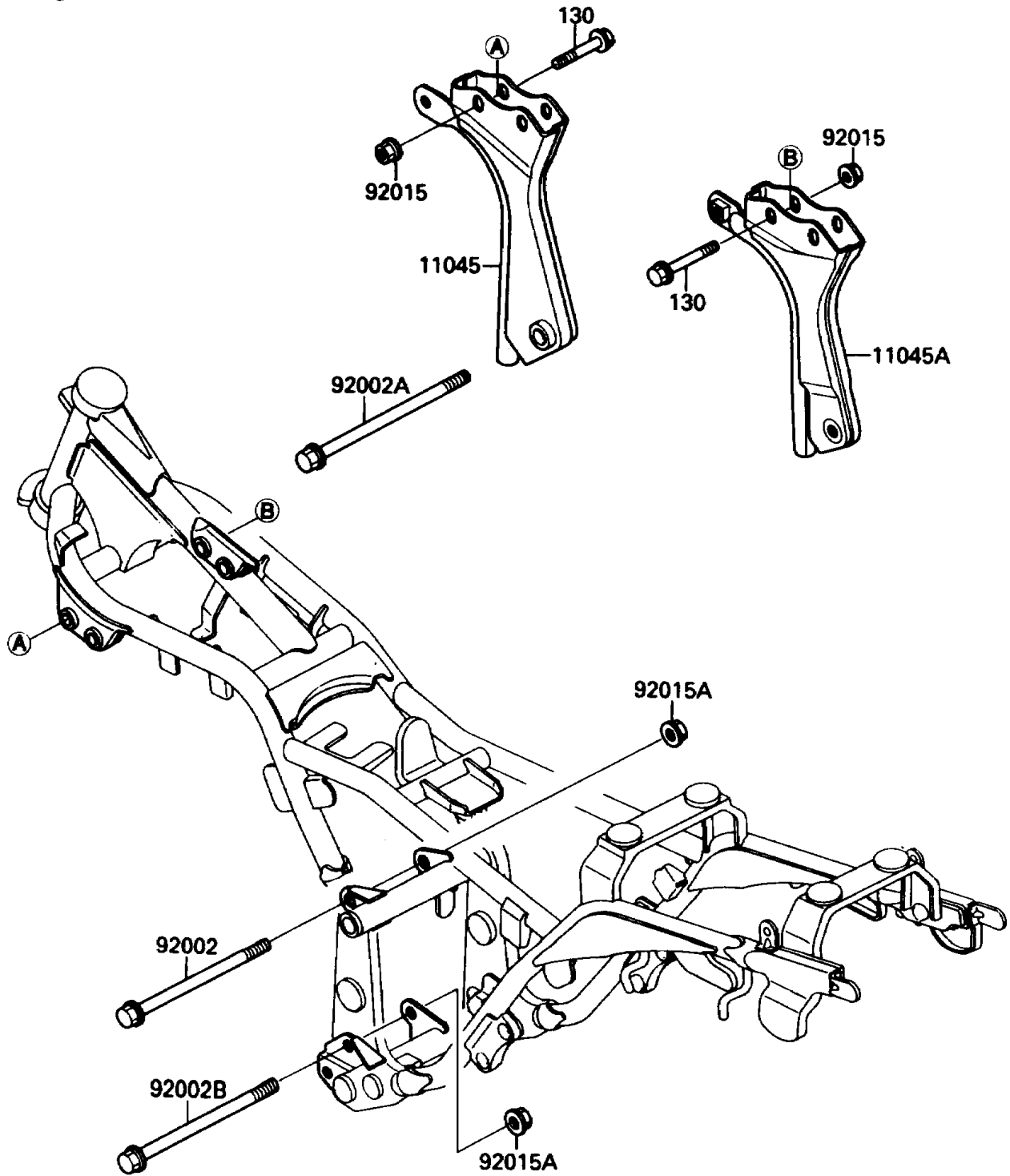

1988 Eliminator PARTS LIST

Frame Fittings

ITEM NAME	PART NUMBER	QUANTITY
BRACKET,ENGINE,LH (Ref # 11045)	11045-1814	1
BRACKET,ENGINE,RH (Ref # 11045A)	11045-1815	1
BOLT,FLANGED,10X130 (Ref # 92002)	92002-1087	1
BOLT,FLANGED,10X170 (Ref # 92002A)	92002-1470	1
BOLT,FLANGED,10X138 (Ref # 92002B)	92002-1795	1
NUT,8MM (Ref # 92015)	92015-1143	4
NUT,FLANGED,10MM (Ref # 92015A)	92015-1180	2
BOLT-FLANGED,8X40 (Ref # 130)	130G0840	4