

1988 Eliminator PARTS DIAGRAM

Meter(s)

F2530-0287

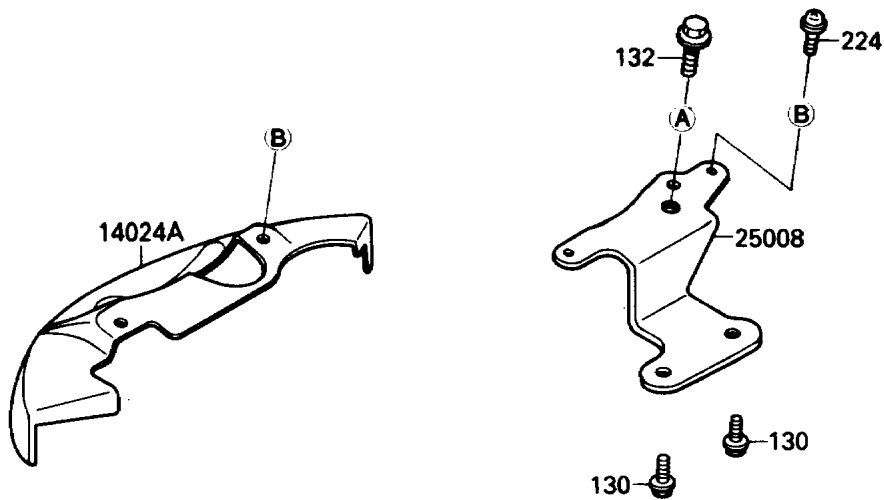
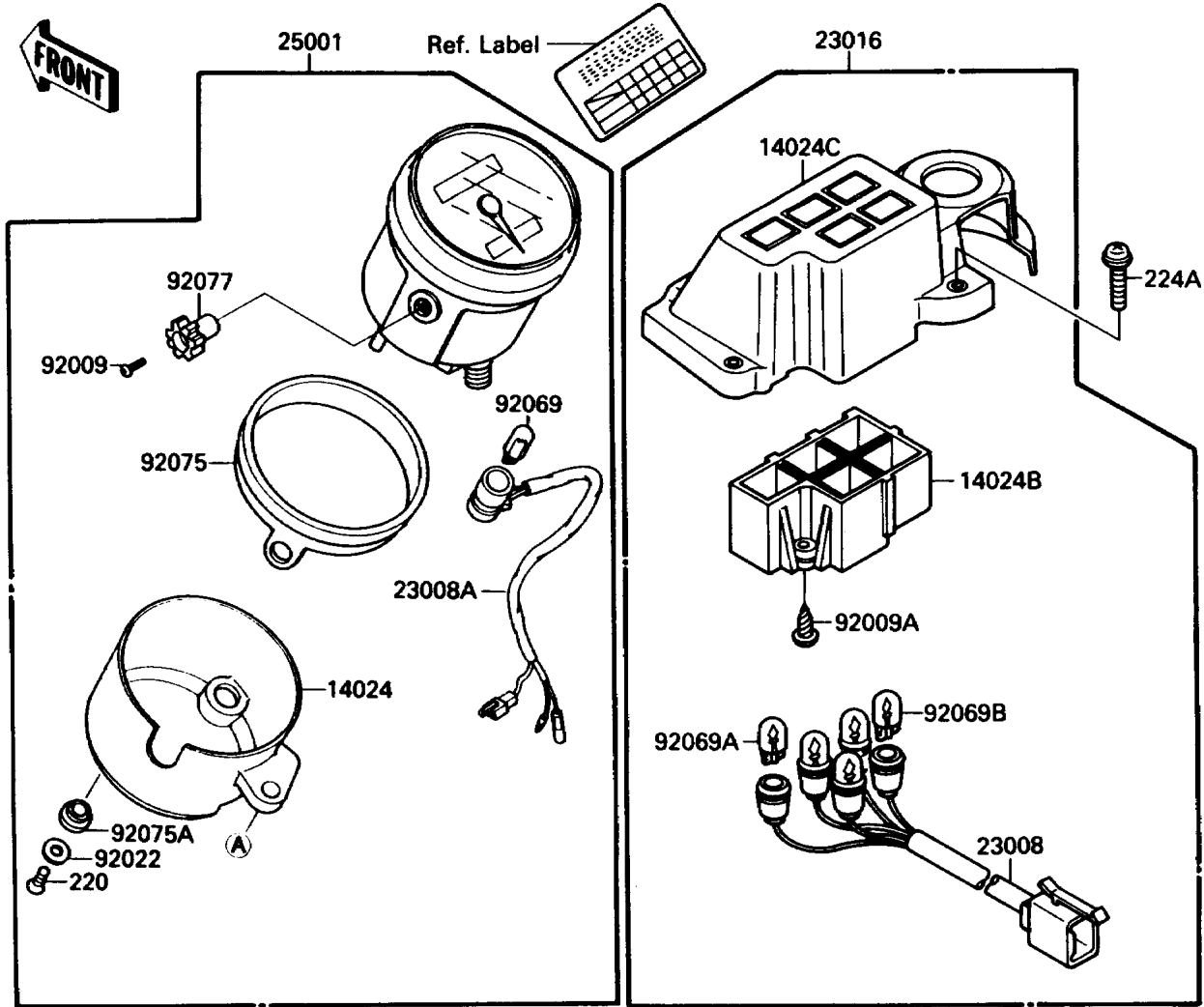

1988 Eliminator PARTS LIST

Meter(s)

ITEM NAME	PART NUMBER	QUANTITY
COVER,SPEEDOMETER (Ref # 14024)	14024-1096	1
COVER,HEAD LAMP (Ref # 14024A)	14024-1564	1
COVER,PILOT BOX,LWR (Ref # 14024B)	14024-1604	1
COVER,PILOT BOX,UPP (Ref # 14024C)	14024-1605	1
SOCKET-ASSY,PILOT BOX (Ref # 23008)	23008-1354	1
SOCKET-ASSY,SPEEDOMETER (Ref # 23008A)	23008-1356	1
LAMP-ASSY,PILOT BOX (Ref # 23016)	23016-1089	1
METER-ASSY,SPEED,MPH (Ref # 25001)	25001-1704	1
BRACKET-METER (Ref # 25008)	25008-1141	1
SCREW,2X6,BLACK (Ref # 92009)	92009-1172	1
SCREW,TAPPING,4X14 (Ref # 92009A)	92009-1503	2
WASHER,4.5X10X0.8 (Ref # 92022)	92022-1822	2
BULB,12V 3.4W (Ref # 92069)	92069-1007	1
BULB,14V 3W (Ref # 92069A)	92069-1068	3
BULB,12V 1.7W (Ref # 92069B)	92069-1070	2
DAMPER,SHOCK,METER (Ref # 92075)	92075-1751	1
DAMPER,METER FITTING (Ref # 92075A)	92075-1753	2
KNOB,METER (Ref # 92077)	92077-1059	1
BOLT-FLANGED,6X14 (Ref # 130)	130D0614	2
BOLT-FLANGED-SMALL (Ref # 132)	132E0620	1
SCREW-PAN-CROS (Ref # 220)	220E0408	2
SCREW-PAN-WP-CROS (Ref # 224)	224B0508	2
SCREW-PAN-WP-CROS,4X20 (Ref # 224A)	224C0420	2