

1988 Eliminator PARTS DIAGRAM

Turn Signals

F2730-0181

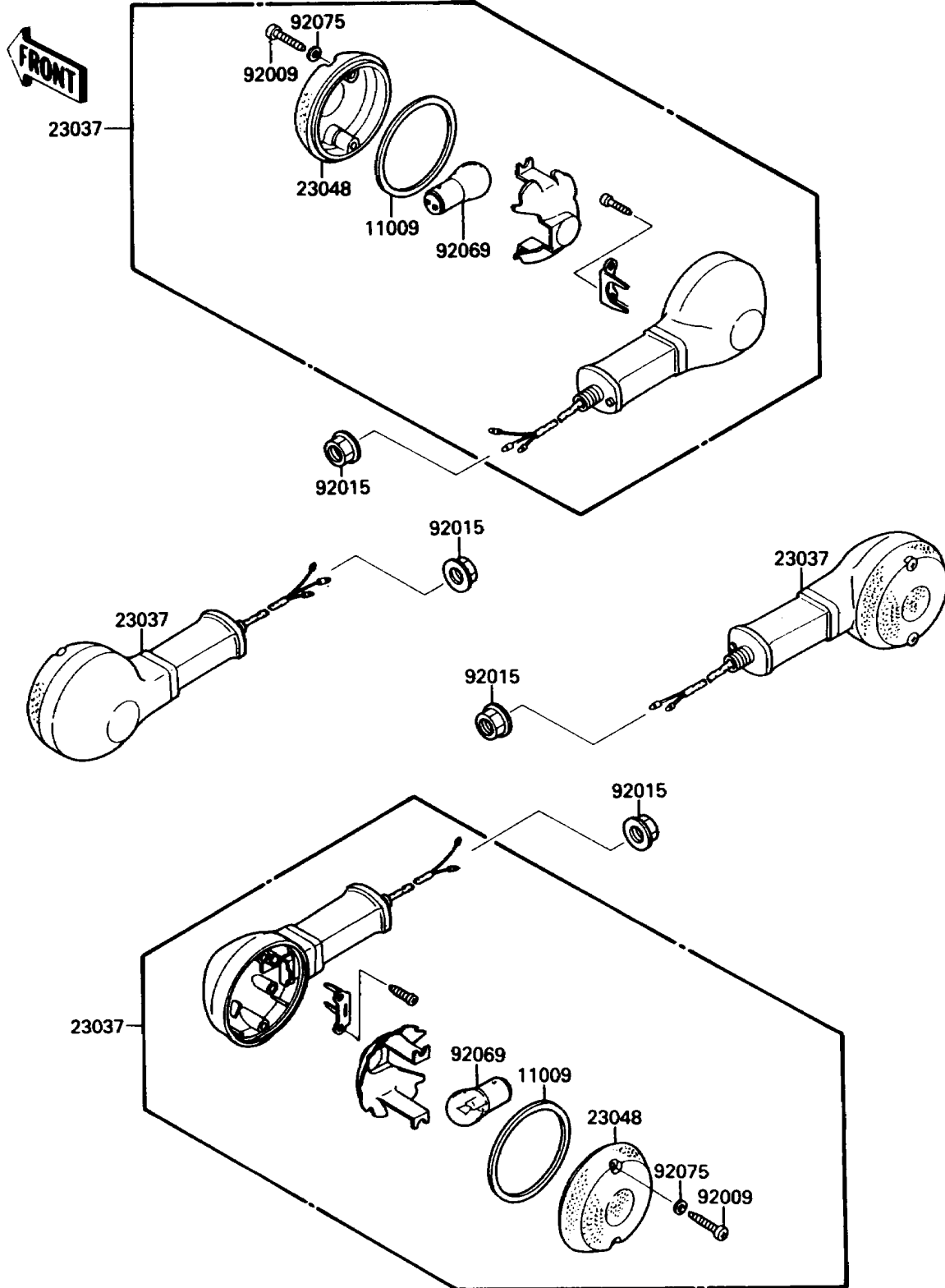

1988 Eliminator PARTS LIST

Turn Signals

ITEM NAME	PART NUMBER	QUANTITY
GASKET,SIGNAL LAMP (Ref # 11009)	11009-1413	4
LAMP-ASSY-SIGNAL (Ref # 23037)	23037-1226	4
LENS-SIGNAL LAMP (Ref # 23048)	23048-1066	4
SCREW,TAPPING,4X25 (Ref # 92009)	92009-1069	8
NUT,FLANGED,10MM (Ref # 92015)	92015-1428	4
BULB,12V 32CP(23W) (Ref # 92069)	92069-055	4
WASHER,PLAIN,4MM (Ref # 92075)	23058-002	8