

# 1992 Eliminator 250 PARTS DIAGRAM

Crankcase

E1411

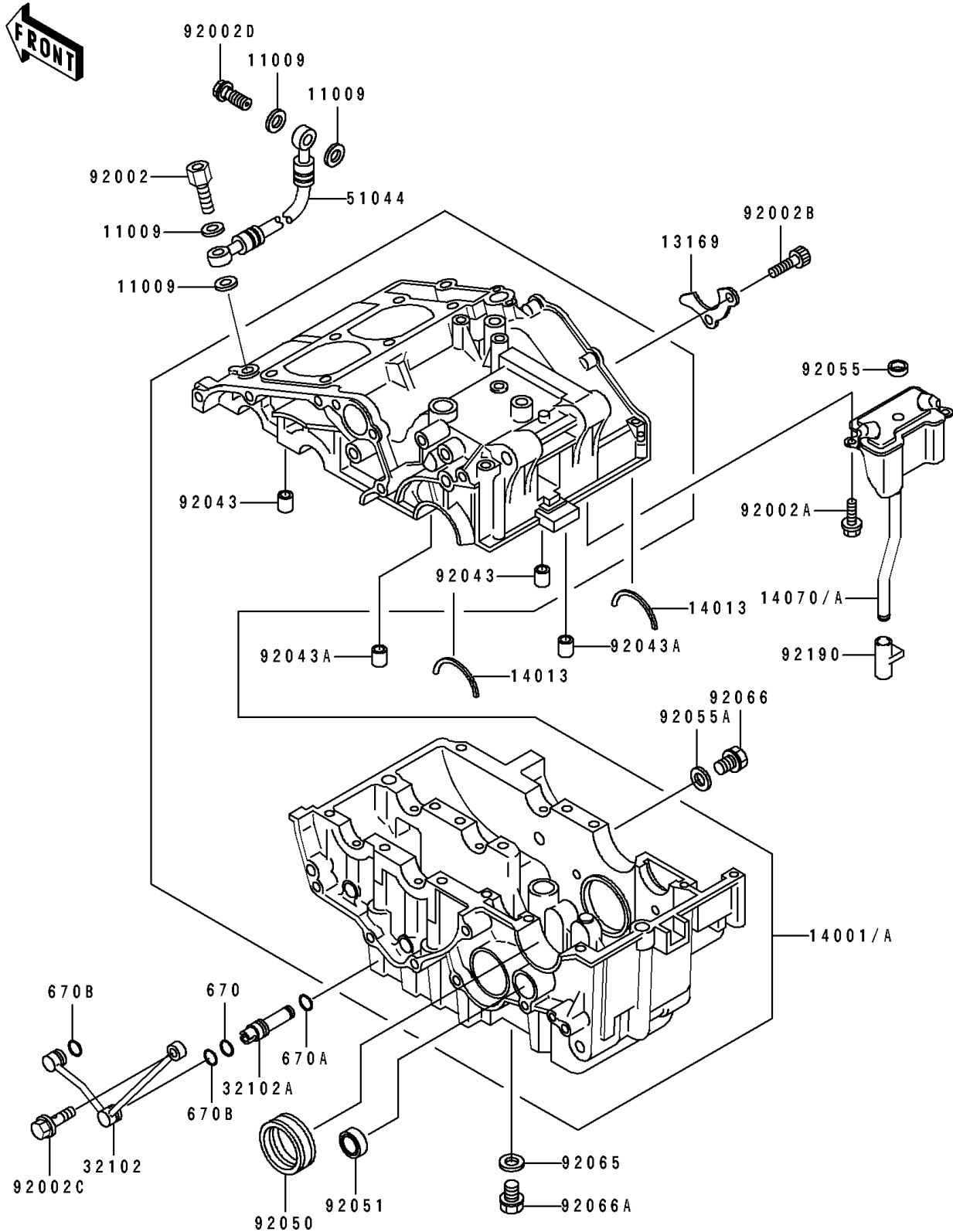

# 1992 Eliminator 250 PARTS LIST

## Crankcase

ITEM NAME	PART NUMBER	QUANTITY
GASKET,10X14.5X1.5 (Ref # 11009)	11009-1105	4
PLATE (Ref # 13169)	13169-1659	1
SET-CRANKCASE (Ref # 14001A)	14001-5237	1
RING-POSITION (Ref # 14013)	14013-004	2
BODY-BREATHER (Ref # 14070)	14070-1065	1
PIPE (Ref # 32102)	32102-1017	1
PIPE (Ref # 32102A)	32102-1018	1
TUBE-ASSY (Ref # 51044)	51044-1074	1
BOLT,OIL SWITCH (Ref # 92002)	92002-1427	1
BOLT,6X10 (Ref # 92002A)	92002-1449	2
BOLT,SOCKET,6X14 (Ref # 92002B)	92002-1592	2
BOLT,BANJO,8X20 (Ref # 92002C)	92002-1705	1
BOLT,OIL,L=23 (Ref # 92002D)	92002-1907	1
PIN,9.2X12X14 (Ref # 92043)	92043-1265	2
PIN,3.5X6X16 (Ref # 92043A)	92043-1309	2
SEAL-OIL,SC325210 (Ref # 92050)	92050-024	1
SEAL-OIL,TB13225.5 (Ref # 92051)	92051-005	1
RING-O,OD=18 (Ref # 92055)	92055-048	1
RING-O (Ref # 92055A)	92055-1146	1
GASKET,12X22X2,DRAIN PLUG (Ref # 92065)	92065-097	1
PLUG,MAIN GALLERY,18X9,BLACK (Ref # 92066)	92066-1096	1
PLUG,OIL DRAIN,12X15 (Ref # 92066A)	92066-1174	1
O RING,9MM (Ref # 670)	670D1509	1
O RING (Ref # 670A)	670D2010	1
O RING,12MM (Ref # 670B)	670D2012	2