

# 1991 Eliminator 250 PARTS DIAGRAM

Oil Pump/Oil Filter

E1710

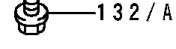
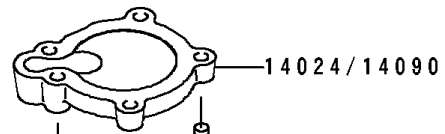
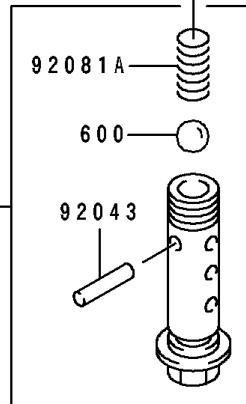
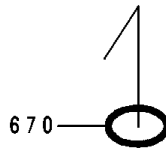
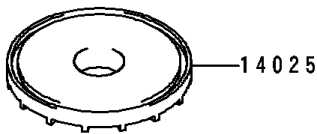
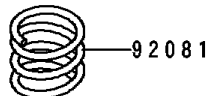
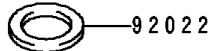
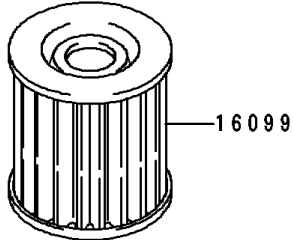
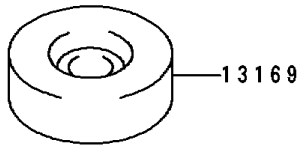
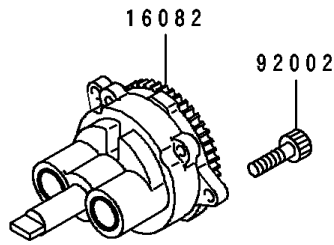
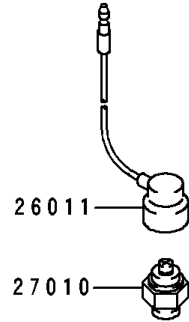
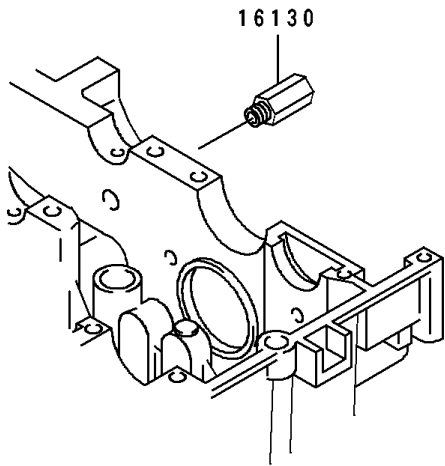

# 1991 Eliminator 250 PARTS LIST

## Oil Pump/Oil Filter

ITEM NAME	PART NUMBER	QUANTITY
GASKET,OIL FILTER COVER (Ref # 11009)	11009-1874	1
PLATE,OIL FILTER (Ref # 13169)	13169-1313	1
COVER,OIL FILTER (Ref # 14024)	14024-1298	1
COVER,OIL FILTER,F.BLACK (Ref # 14025)	14025-1422	1
PUMP-ASSY-OIL (Ref # 16082)	16082-1078	1
ELEMENT-OIL FILTER (Ref # 16099)	16099-003	1
FILTER,OIL (Ref # 16111)	16111-003	1
VALVE,OIL FILTER (Ref # 16126)	16126-1108	1
VALVE-ASSY-RELIEF (Ref # 16130)	16130-1001	1
WIRE-LEAD (Ref # 26011)	26011-1371	1
SWITCH,OIL PRESSURE (Ref # 27010)	27010-1313	1
BOLT,SOCKET,6X25 (Ref # 92002)	92002-1696	2
WASHER,20.5X30X1 (Ref # 92022)	92022-1012	1
PIN,SPRING,2X20 (Ref # 92043)	92043-111	1
SPRING,OIL FILTER (Ref # 92081)	92081-1018	1
SPRING (Ref # 92081A)	92081-109	1
BOLT-FLANGED-SMALL (Ref # 132A)	132J0630	5
BALL-STEEL,3/8" (Ref # 600)	600A1200	1
O RING,16MM (Ref # 670)	670B2016	1
O RING,90MM (Ref # 671)	671B2590	1