

1994 Eliminator 250 PARTS DIAGRAM

Battery Case

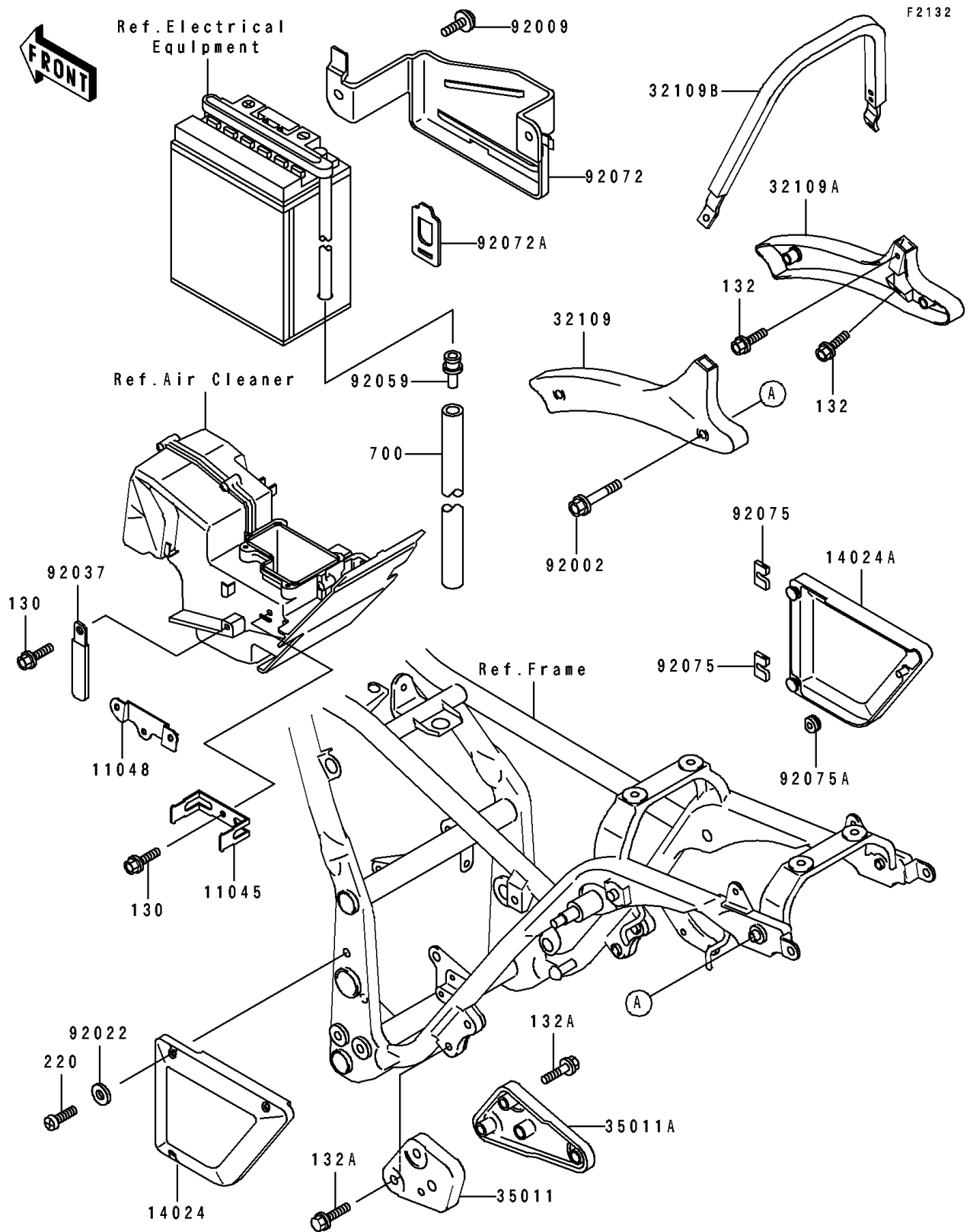

1994 Eliminator 250 PARTS LIST

Battery Case

ITEM NAME	PART NUMBER	QUANTITY
BRACKET,IGNITER (Ref # 11048)	11048-1328	1
COVER,SIDE,LWR,LH,BLACK (Ref # 14024)	14024-1597-6Z	1
COVER,SIDE,LWR,RH,BLACK (Ref # 14024A)	14024-1598-6Z	1
GRIP-FRAME,LWR,LH (Ref # 32109)	32109-1166	1
GRIP-FRAME,LWR,RH (Ref # 32109A)	32109-1167	1
GRIP-FRAME,UPP (Ref # 32109B)	32109-1218	1
STAY,MUFFLER,LH (Ref # 35011)	35011-1371	1
STAY,MUFFLER,RH (Ref # 35011A)	35011-1372	1
BOLT,FLANGED,8X42.5 (Ref # 92002)	92002-1974	4
SCREW,6X14 (Ref # 92009)	92009-1288	2
WASHER,NYLON,5.3X11.5X1.5 (Ref # 92022)	92022-1521	3
CLAMP,WIRING HARNESS (Ref # 92037)	92037-1069	1
TUBE,BATTERY VENT HOSE (Ref # 92059)	92059-1715	1
BAND,BATTERY (Ref # 92072)	92072-1224	1
BAND,TOOL (Ref # 92072A)	92072-1228	1
DAMPER (Ref # 92075)	92075-1967	2
DAMPER (Ref # 92075A)	92075-1986	1
BOLT-FLANGED,6X10,BLACK (Ref # 130)	130C0610	2
BOLT-FLANGED-SMALL (Ref # 132)	132E0610	4
BOLT-FLANGED-SMALL (Ref # 132A)	132E0835	4
SCREW-PAN-CROS (Ref # 220)	220C0520	3
TUBE-PVC,5X600 (Ref # 700)	700Q05600	1