

1992 Eliminator 250 PARTS DIAGRAM

Suspension/Shock Absorber

F 2151

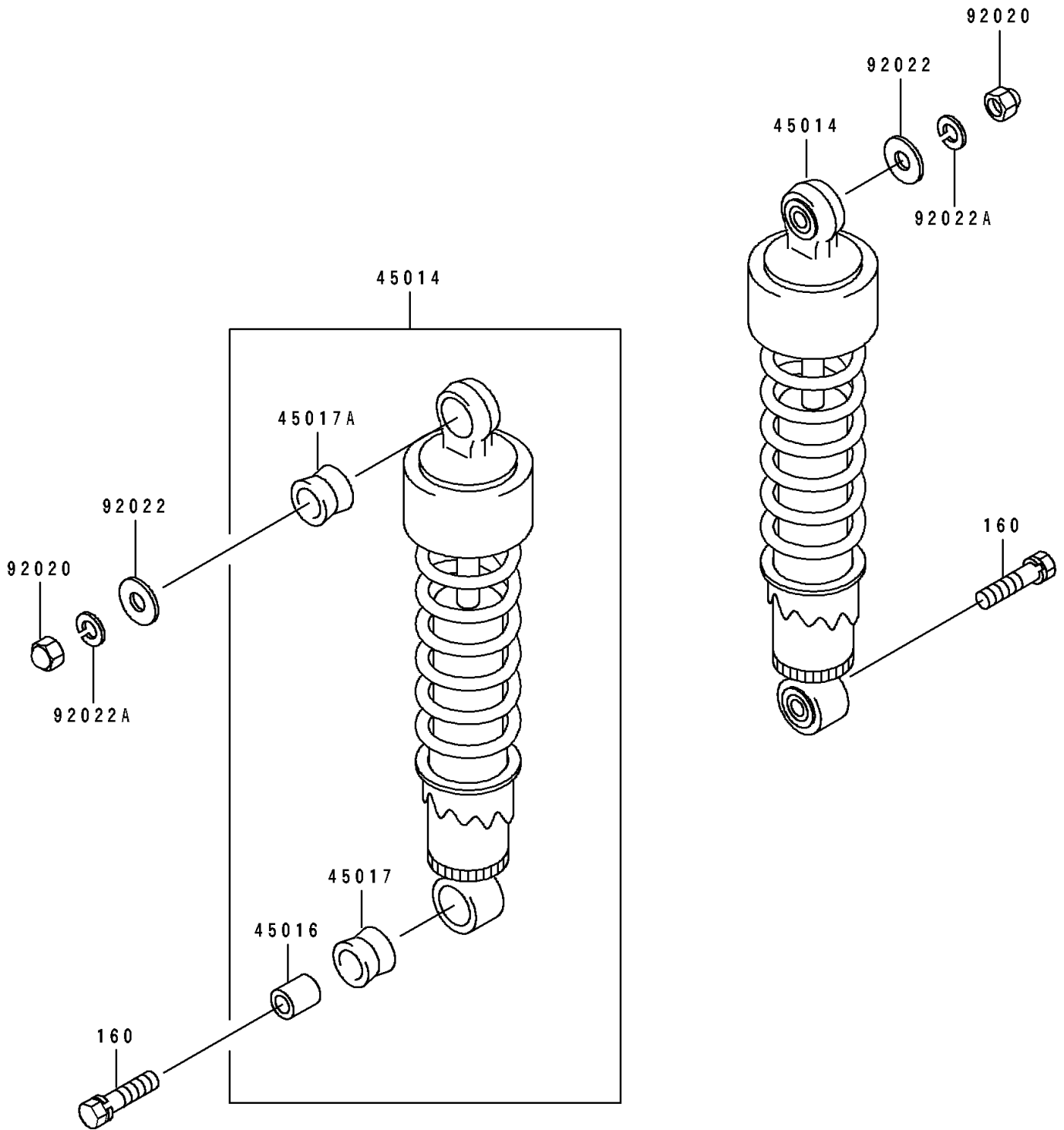

1992 Eliminator 250 PARTS LIST

Suspension/Shock Absorber

ITEM NAME	PART NUMBER	QUANTITY
SHOCKABSORBER (Ref # 45014)	45014-1378	2
COLLAR,SHOCKABSORBER (Ref # 45016)	45016-008	2
DAMPER,SHOCKABSORBER (Ref # 45017)	45017-012	2
DAMPER,SHOCKABSORBER (Ref # 45017A)	45017-015	2
NUT,CAP,10MM (Ref # 92020)	92020-003	2
WASHER,10.5X26X2.3 (Ref # 92022)	92022-044	2
WASHER,SPRING,10MM (Ref # 92022A)	92022-1540	2
BOLT-FINE-WS (Ref # 160)	160N1040	2