

# 1993 Eliminator 250 PARTS DIAGRAM

Chassis Electrical Equipment

F2760

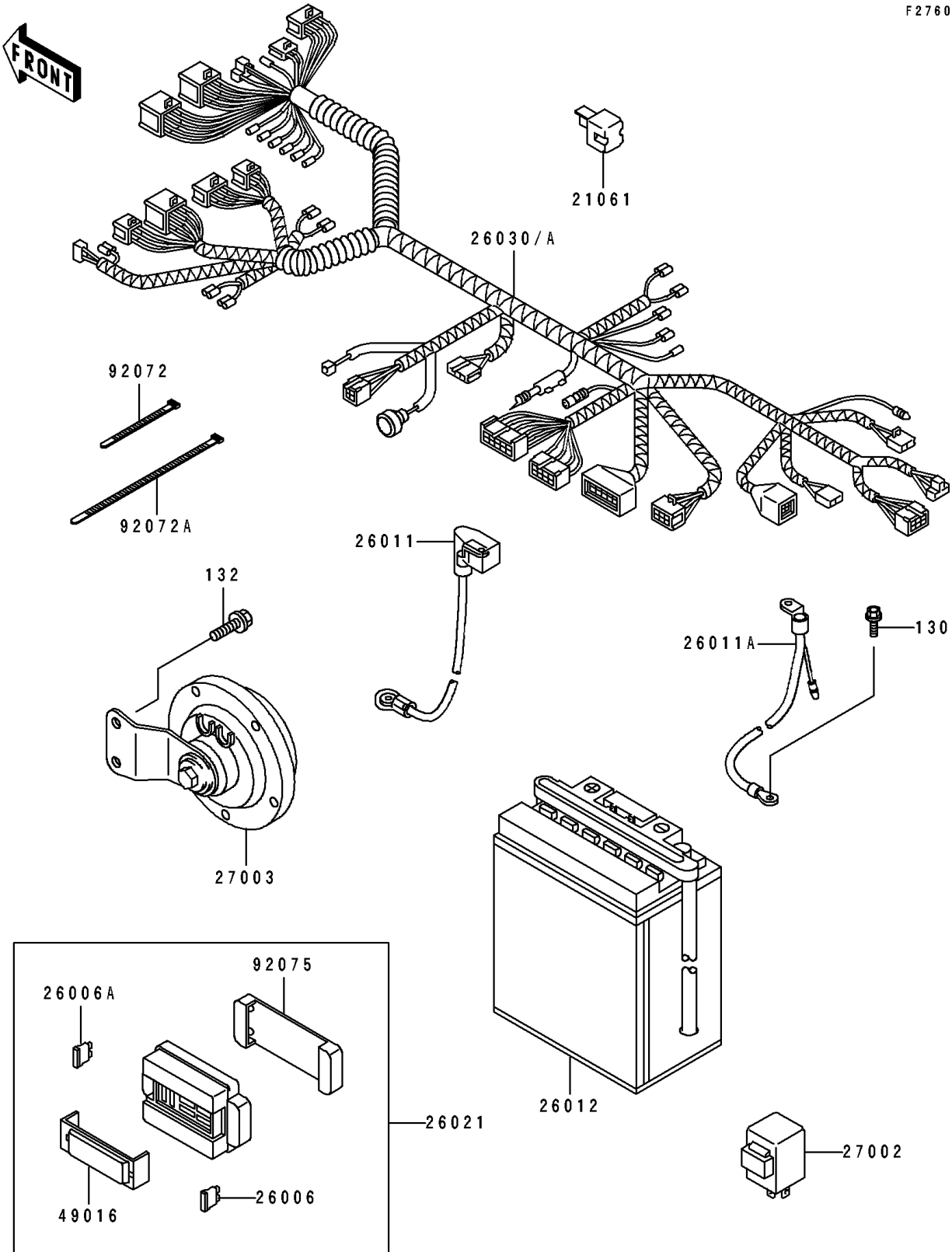

# 1993 Eliminator 250 PARTS LIST

## Chassis Electrical Equipment

ITEM NAME	PART NUMBER	QUANTITY
FUSE,30A-G (Ref # 26006)	26006-1067	1
FUSE,10A-R (Ref # 26006A)	26006-1068	5
WIRE-LEAD,BATTERY(+) (Ref # 26011)	26011-1401	1
WIRE-LEAD,BATTERY(-) (Ref # 26011A)	26011-1402	1
BATTERY,12V 8AH,FB9L-A2K(K2) (Ref # 26012)	26012-1205	1
JUNCTION BOX (Ref # 26021)	26021-1077	1
HARNESS,MAIN (Ref # 26030)	26030-1059	1
RELAY-ASSY,TURN SIGNAL (Ref # 27002)	27002-1053	1
HORN (Ref # 27003)	27003-1275	1
COVER-SEAL,FUSE (Ref # 49016)	49016-1125	1
BAND,L=185 (Ref # 92072)	92072-1195	9
BAND,L=365 (Ref # 92072A)	92072-1197	3
DAMPER,JUNCTION BOX (Ref # 92075)	92075-1688	1
BOLT-FLANGED,6X12 (Ref # 130)	130B0612	1
BOLT-FLANGED-SMALL,6X10 (Ref # 132)	132J0610	2