

# 1986 454 LTD PARTS DIAGRAM

Cylinder Head Cover

E1112-0079

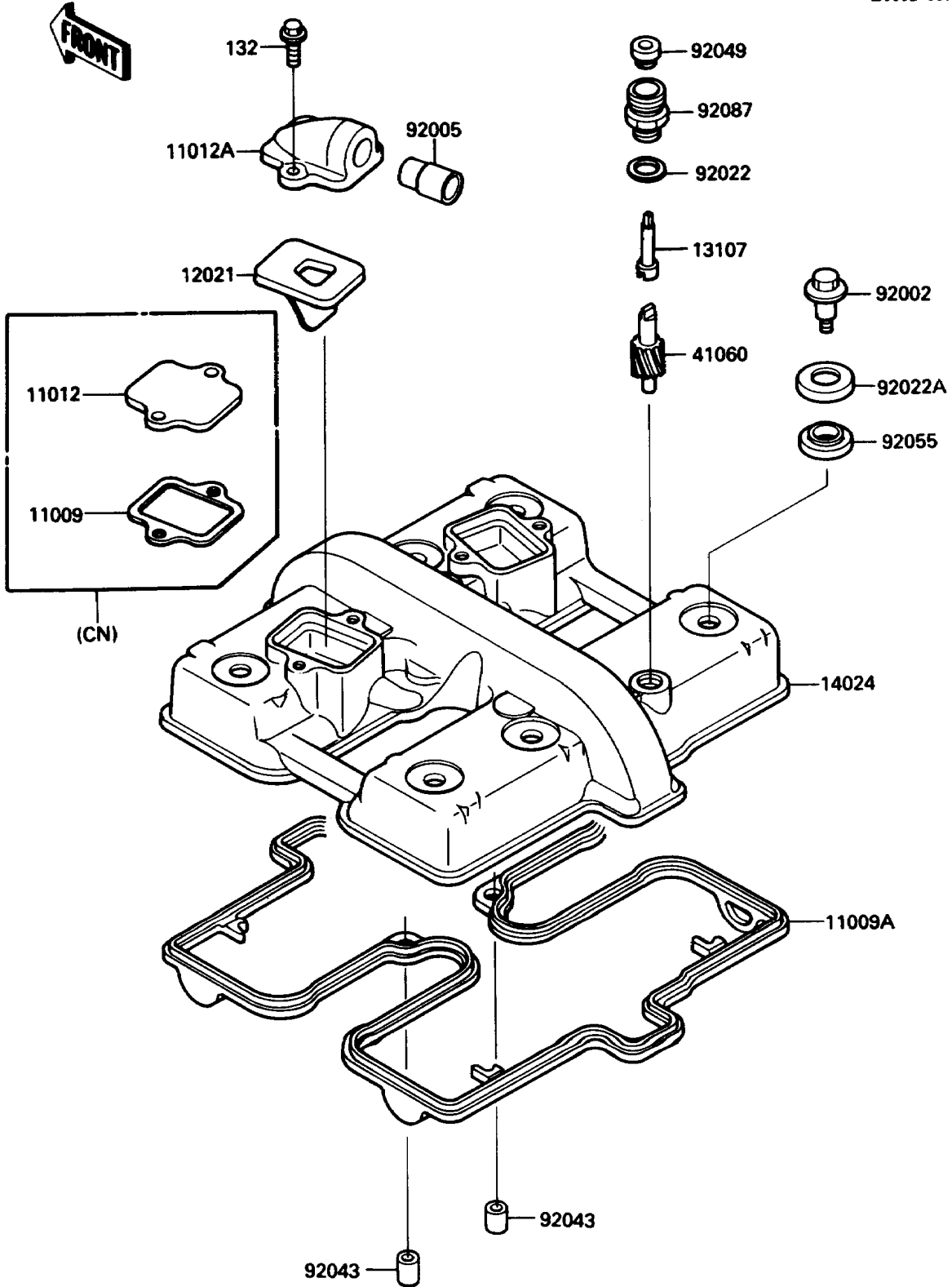

# 1986 454 LTD PARTS LIST

## Cylinder Head Cover

ITEM NAME	PART NUMBER	QUANTITY
GASKET, REED VALVE (Ref # 11009)	11009-1246	2
GASKET, CYLINDER HEAD COVER (Ref # 11009A)	11009-1483	1
CAP, CYLINDER HEAD COVER (Ref # 11012)	11012-1212	2
CAP, REED VALVE (Ref # 11012A)	11012-1435	2
VALVE-ASSY-REED (Ref # 12021)	12021-1026	2
SHAFT, METER GEAR (Ref # 13107)	13107-1140	1
COVER, CYLINDER HEAD (Ref # 14024)	14025-1702	1
GEAR-METER SCREW (Ref # 41060)	41060-1109	1
BOLT, HEAD COVER (Ref # 92002)	92002-1504	6
FITTING, REED VALVE (Ref # 92005)	92005-1006	2
WASHER (Ref # 92022)	92022-1211	1
WASHER, HEAD COVER BOLT (Ref # 92022A)	92022-1637	6
PIN, DOWEL, 8X10 (Ref # 92043)	92043-1302	2
SEAL-OIL (Ref # 92049)	92050-075	1
RING-O, HEAD COVER BOLT (Ref # 92055)	92055-1225	6
BUSHING-METER GEAR (Ref # 92087)	92087-1053	1
BOLT-FLANGED-SMALL (Ref # 132)	132E0616	4