

# 1987 454 LTD PARTS DIAGRAM

## Carburetor Parts

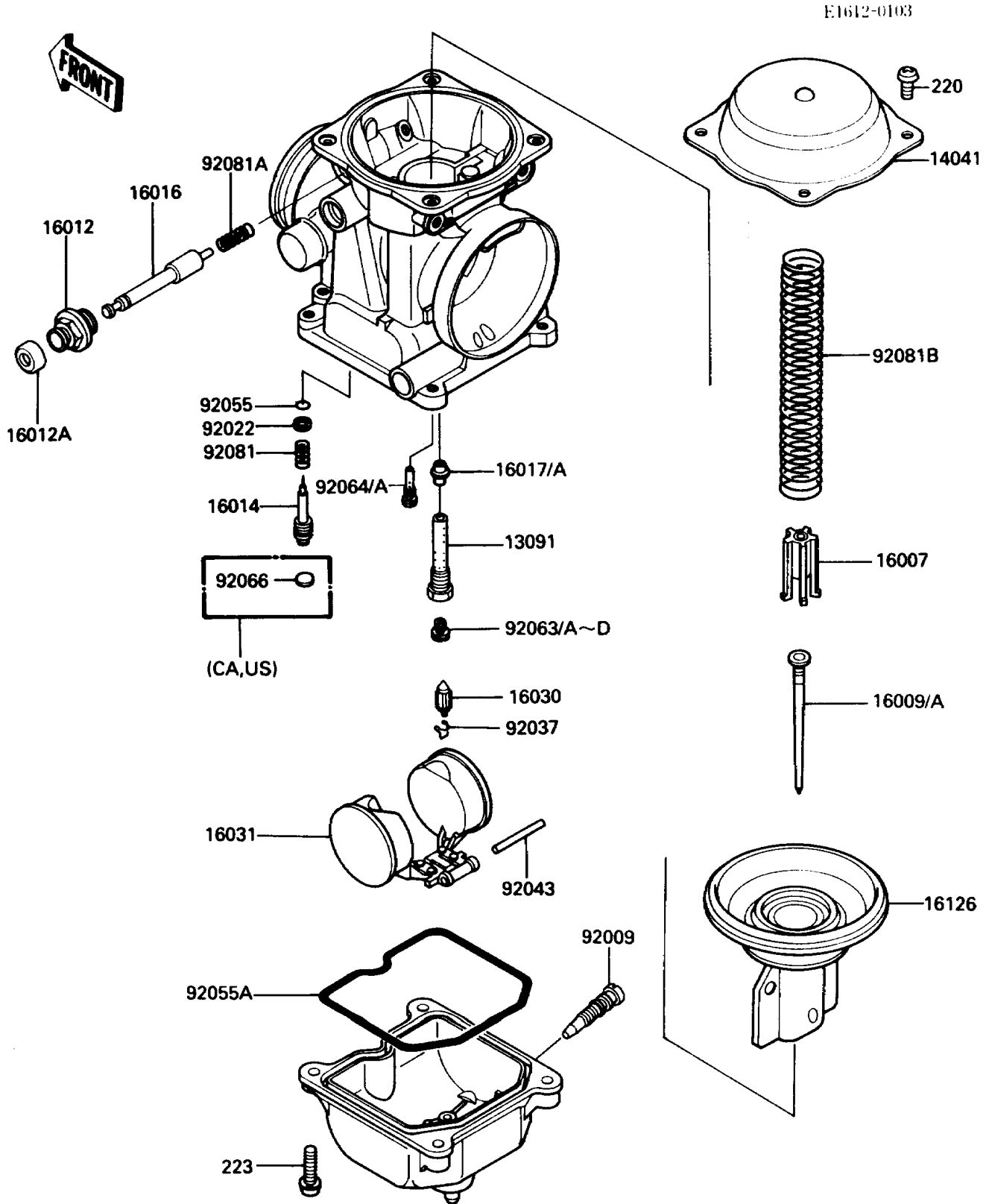

# 1987 454 LTD PARTS LIST

## Carburetor Parts

ITEM NAME	PART NUMBER	QUANTITY
HOLDER,NEEDLE JET (Ref # 13091)	13091-1347	2
COVER-COMP,MIXING CHAMBER (Ref # 14041)	14041-1065	2
SEAT-SPRING,VALVE (Ref # 16007)	16007-1117	2
NEEDLE-JET,N31D (Ref # 16009)	16009-1257	2
NEEDLE-JET,N31E (Ref # 16009A)	16009-1258	2
CAP-STARTER PLUNGER (Ref # 16012)	16012-1051	2
CAP-STARTER PLUNGER (Ref # 16012A)	16012-1052	2
SCREW-PILOT AIR (Ref # 16014)	16014-1054	2
PLUNGER,STARTER (Ref # 16016)	16016-1061	2
JET-NEEDLE,01B38 (Ref # 16017)	16017-1276	2
JET-NEEDLE (Ref # 16017A)	16017-1277	2
VALVE-FLOAT (Ref # 16030)	16030-1007	2
FLOAT (Ref # 16031)	16031-1056	2
VALVE,VACUUM,60PS (Ref # 16126)	16126-1173	2
SCREW,DRAIN,M6X1.0 (Ref # 92009)	92009-1434	2
WASHER,PLAIN (Ref # 92022)	92022-1003	2
CLAMP,FLOAT VALVE (Ref # 92037)	16044-007	2
PIN,FLOAT (Ref # 92043)	92043-1207	2
RING-O,PILOT ADJUST (Ref # 92055)	92055-1002	2
RING-O,FLOAT CHAMBER (Ref # 92055A)	92055-1222	2
JET-MAIN,2ND,#125 (Ref # 92063)	92063-1069	2
JET-MAIN,#120 (Ref # 92063A)	92063-1072	2
JET-MAIN,2ND,#122 (Ref # 92063B)	92063-1073	2
JET-MAIN,2ND,#128 (Ref # 92063C)	92063-1074	2
JET-MAIN,#130 (Ref # 92063D)	92063-1075	2
JET-PILOT,#35 (Ref # 92064)	92064-1101	2
JET-PILOT,#32 (Ref # 92064A)	92064-1117	2
PLUG,PILOT AIR SCREW,6.9X2 (Ref # 92066)	92066-1051	2
SPRING,PILOT ADJUST SCREW (Ref # 92081)	92081-1002	2

# 1987 454 LTD PARTS LIST

## Carburetor Parts

ITEM NAME	PART NUMBER	QUANTITY
SPRING,STARTER PLUNGER (Ref # 92081A)	92081-1761	2
SPRING,VACUUM VALVE (Ref # 92081B)	92081-1874	2
SCREW-PAN-CROS (Ref # 220)	220B0408	7
SCREW-PAN-WS-CROS (Ref # 223)	223C0416	8