

1986 454 LTD PARTS DIAGRAM

Battery Case

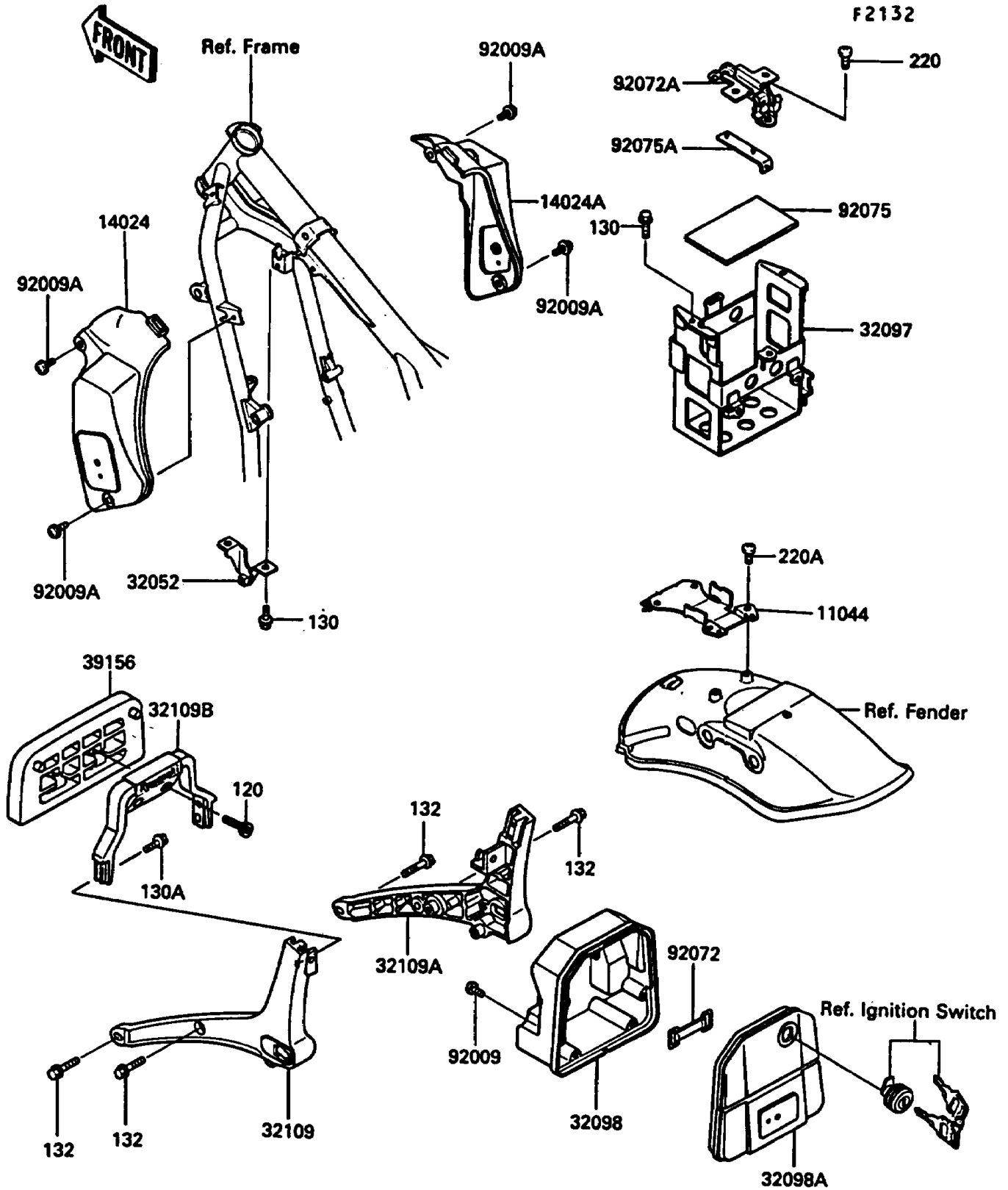

1986 454 LTD PARTS LIST

Battery Case

ITEM NAME	PART NUMBER	QUANTITY
BRACKET,ELECTRIC BASE (Ref # 11044)	11043-1174	1
COVER,HEAD GUSSET,LH (Ref # 14024)	14024-1105	1
COVER,HEAD GUSSET,RH (Ref # 14024A)	14024-1106	1
BRACKET-TANK (Ref # 32052)	32052-1179	1
CASE-BATTERY (Ref # 32097)	32097-1114	1
CASE-TOOL,BASE (Ref # 32098)	32098-1060	1
CASE-TOOL,CAP (Ref # 32098A)	32098-1061	1
GRIP-FRAME,LH (Ref # 32109)	32109-1117	1
GRIP-FRAME,RH (Ref # 32109A)	32109-1118	1
GRIP-FRAME,UPP (Ref # 32109B)	32109-1119	1
PAD,GRABRAIL (Ref # 39156)	39156-1055	1
SCREW,TAPPING,5X16 (Ref # 92009)	92009-1264	4
SCREW,6X14 (Ref # 92009A)	92009-1288	4
BAND,L=50 (Ref # 92072)	92072-066	1
BAND,BATTERY (Ref # 92072A)	92072-1178	1
DAMPER (Ref # 92075)	92075-1076	1
DAMPER,BATTERY BAND (Ref # 92075A)	92075-1735	1
BOLT-SOCKET,6X20 (Ref # 120)	120P0620	2
BOLT-FLANGED,6X12 (Ref # 130)	130B0612	4
BOLT-FLANGED (Ref # 130A)	130B0614	4
BOLT-FLANGED-SMALL (Ref # 132)	132E0830	4
SCREW-PAN-CROS,6X12 (Ref # 220)	220B0612	1
SCREW-PAN-CROS (Ref # 220A)	220D0610	2