

1987 454 LTD PARTS DIAGRAM

Footrests

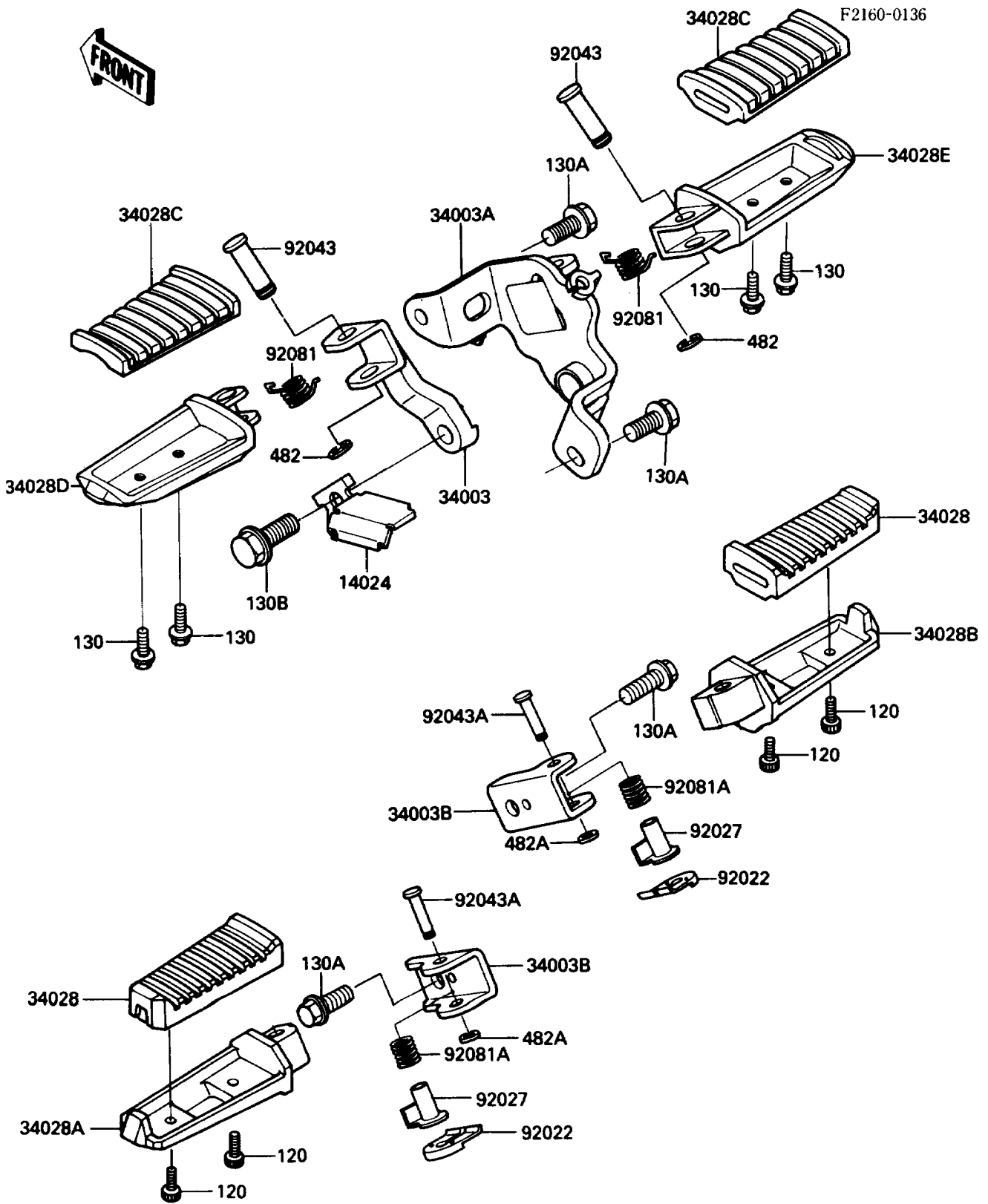

1987 454 LTD PARTS LIST

Footrests

ITEM NAME	PART NUMBER	QUANTITY
COVER,SIDE STAND SWITCH (Ref # 14024)	14024-1077	1
HOLDER-STEP,FR,LH (Ref # 34003)	34003-1229	1
HOLDER-STEP,FR,RH (Ref # 34003A)	34003-1230	1
HOLDER-STEP,RR (Ref # 34003B)	34003-1231	2
STEP,RR,RUBBER (Ref # 34028)	34028-1060	2
STEP,RR,LH (Ref # 34028A)	34028-1121	1
STEP,RR,RH (Ref # 34028B)	34028-1122	1
STEP,FR,RUBBER (Ref # 34028C)	34028-1132	2
STEP,FR,LH (Ref # 34028D)	34028-1160	1
STEP,FR,RH (Ref # 34028E)	34028-1161	1
WASHER,STOPPER (Ref # 92022)	92022-1661	2
COLLAR,STEP (Ref # 92027)	92027-1732	2
PIN,12X37 (Ref # 92043)	92043-1144	2
PIN,6X34 (Ref # 92043A)	92043-1271	2
SPRING,STEP RETURN (Ref # 92081)	92081-1587	2
SPRING,STEP,RR (Ref # 92081A)	92081-1612	2
BOLT-SOCKET (Ref # 120)	120Z0514	4
BOLT-FLANGED (Ref # 130)	130B0510	4
BOLT-FLANGED,10X20 (Ref # 130A)	130J1020	4
BOLT-FLANGED (Ref # 130B)	130J1230	1
CIRCLIP-TYPE-E,10MM (Ref # 482)	482L0100	2
CIRCLIP-TYPE-E,5MM (Ref # 482A)	482L5000	2