

# 1986 454 LTD PARTS DIAGRAM

Stand(s)

F2190-0179

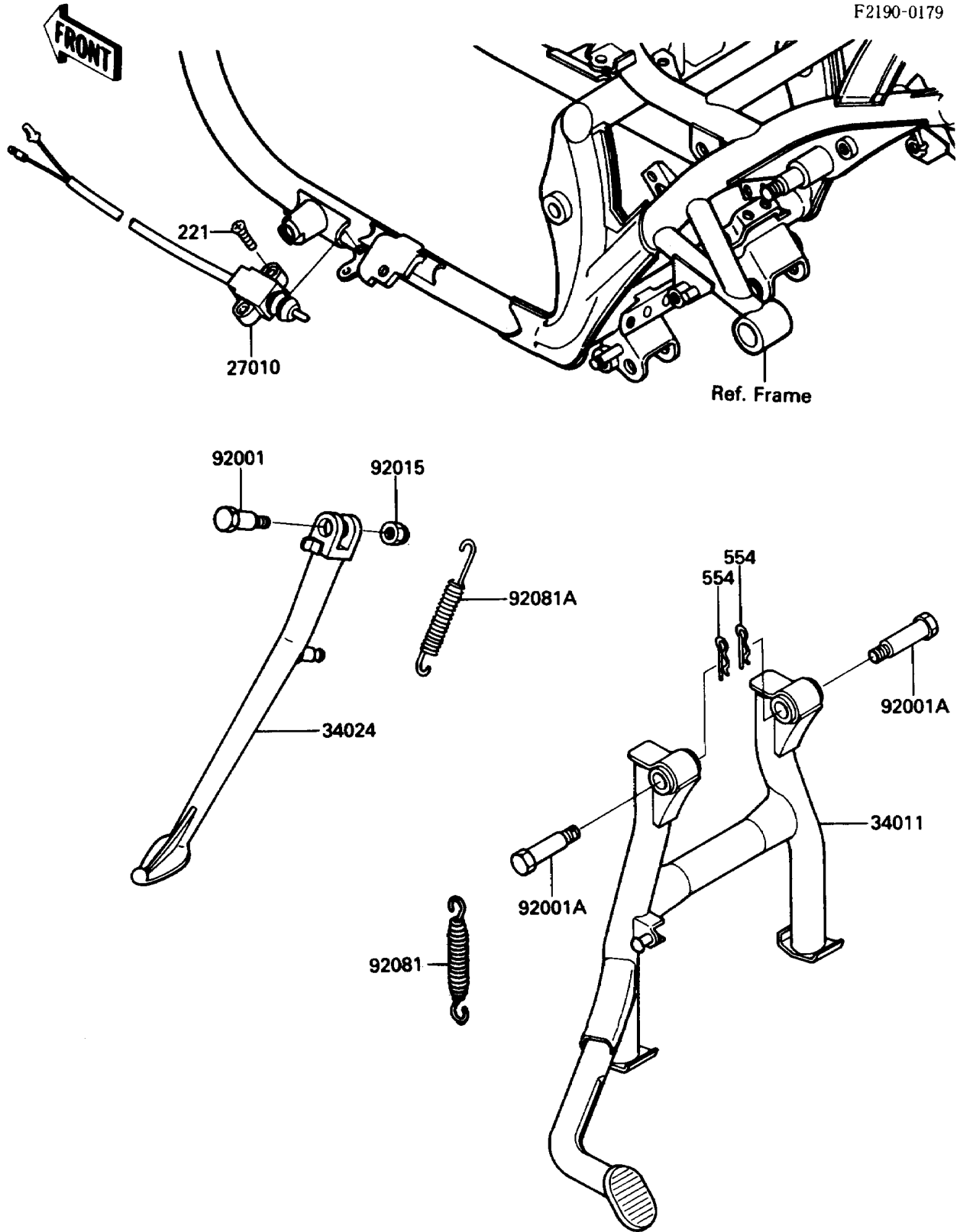

# 1986 454 LTD PARTS LIST

Stand(s)

ITEM NAME	PART NUMBER	QUANTITY
SWITCH,SIDE STAND (Ref # 27010)	27010-1065	1
STAND-CENTER (Ref # 34011)	34011-1119	1
STAND-SIDE (Ref # 34024)	34024-1189	1
BOLT,SIDE STAND,BLACK (Ref # 92001)	92001-1543	1
BOLT,CENTER STAND,10MM (Ref # 92001A)	92001-1818	2
NUT,LOCK,10MM,BLACK (Ref # 92015)	92015-1188	1
SPRING,STAND,CNT (Ref # 92081)	92081-1145	1
SPRING,SIDE STAND (Ref # 92081A)	92081-1727	1
SCREW-CSK-CROS (Ref # 221)	221C0520	2
PIN-SNAP,10MM (Ref # 554)	554A1000	2