

1988 454 LTD PARTS DIAGRAM

Brake Pedal/Torque Link

F2260-0153

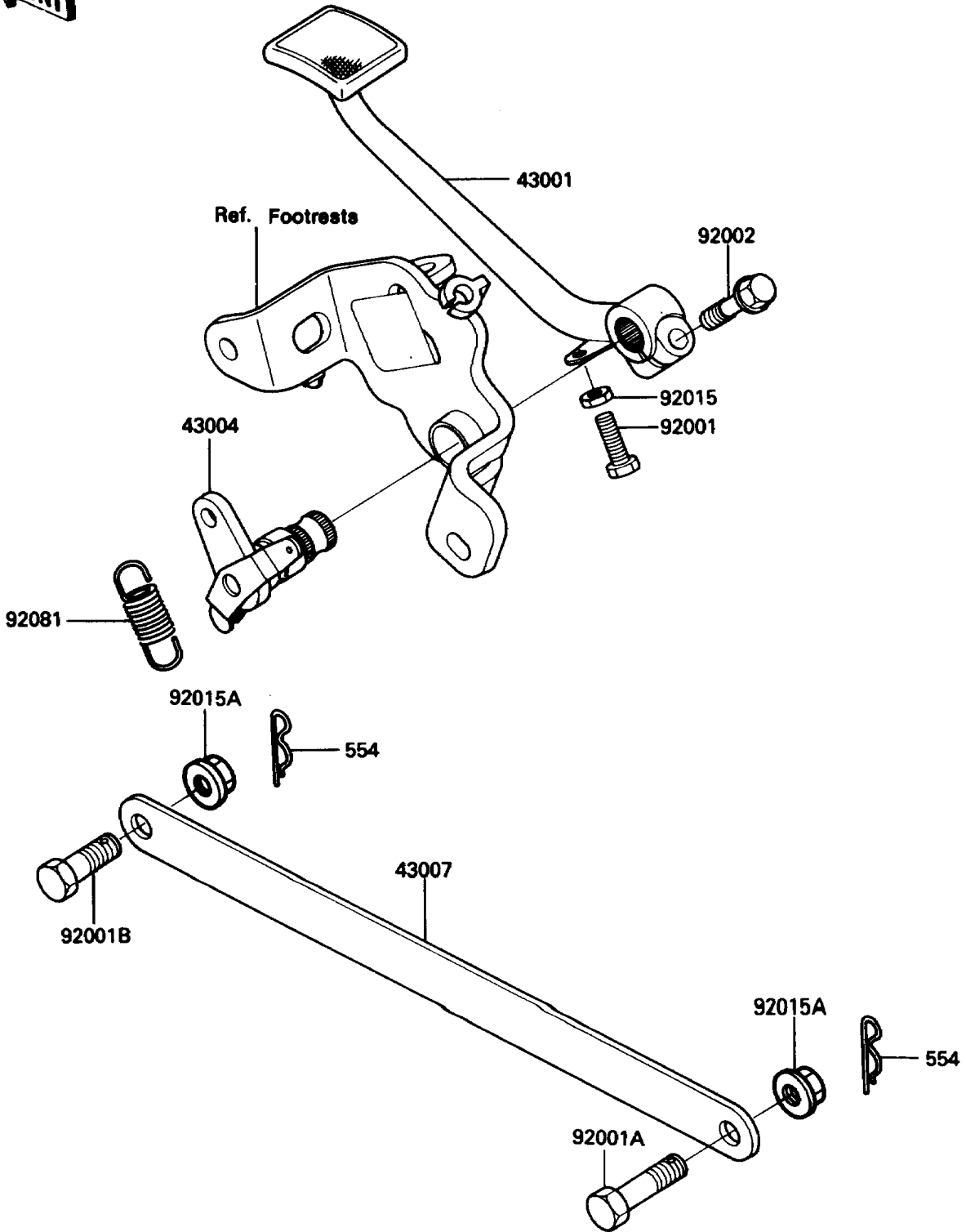

1988 454 LTD PARTS LIST

Brake Pedal/Torque Link

ITEM NAME	PART NUMBER	QUANTITY
LEVER-BRAKE,PEDAL (Ref # 43001)	43001-1179	1
SHAFT-BRAKE (Ref # 43004)	43004-1110	1
ROD-TORQUE,RR (Ref # 43007)	43007-1026	1
BOLT,6X25 (Ref # 92001)	92001-1090	1
BOLT,10X37 (Ref # 92001A)	92001-1519	1
BOLT,10X29 (Ref # 92001B)	92003-096	1
BOLT,FLANGED,8X25 (Ref # 92002)	92002-1201	1
NUT,6MM (Ref # 92015)	92015-1391	1
NUT,FLANGED,10MM (Ref # 92015A)	92015-1428	2
SPRING,BRAKE PEDAL (Ref # 92081)	92081-1147	1
PIN-SNAP,8MM (Ref # 554)	554A0800	2