

1994 Vulcan 500 PARTS DIAGRAM

Cylinder Head Cover

E1112

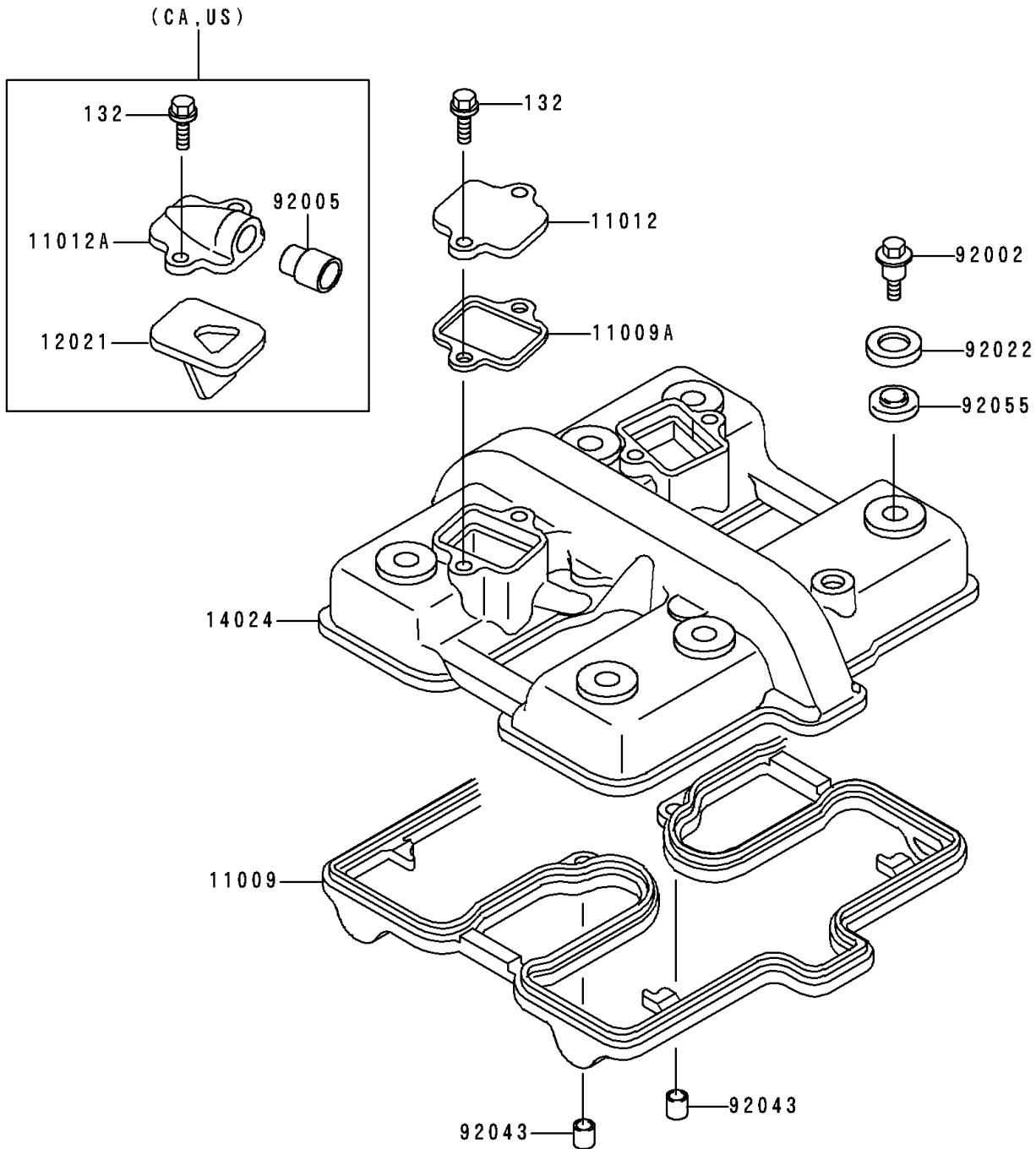

1994 Vulcan 500 PARTS LIST

Cylinder Head Cover

ITEM NAME	PART NUMBER	QUANTITY
BOLT-FLANGED-SMALL (Ref # 132)	132E0616	4
GASKET,CYLINDER HEAD COVER (Ref # 11009)	11009-1483	1
COVER,HEAD (Ref # 14024)	14024-1862	1
BOLT,HEAD COVER (Ref # 92002)	92002-1595	6
WASHER,HEAD COVER BOLT (Ref # 92022)	92022-1637	6
PIN,DOWEL,8X10 (Ref # 92043)	92043-1302	2
RING-O,HEAD COVER BOLT (Ref # 92055)	92055-1225	6
GASKET,REED VALVE (Ref # 11009A)	11009-1879	2
CAP,CYLINDER HEAD COVER (Ref # 11012)	11012-1212	2
CAP,REED VALVE (Ref # 11012A)	11012-1435	2
VALVE-ASSY-REED (Ref # 12021)	12021-1026	2
FITTING,REED VALVE (Ref # 92005)	92005-1006	2