

# 1993 Vulcan 500 PARTS DIAGRAM

Air Cleaner

E1130

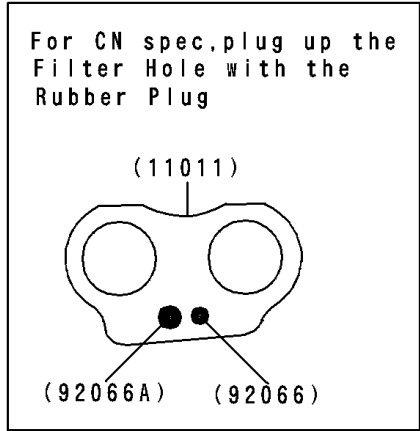
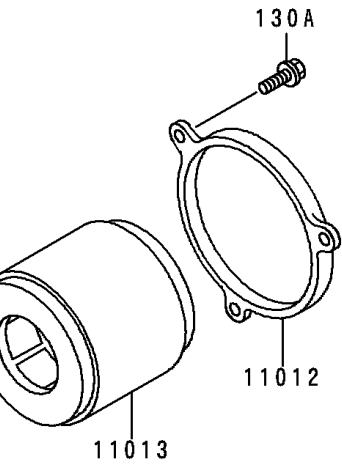
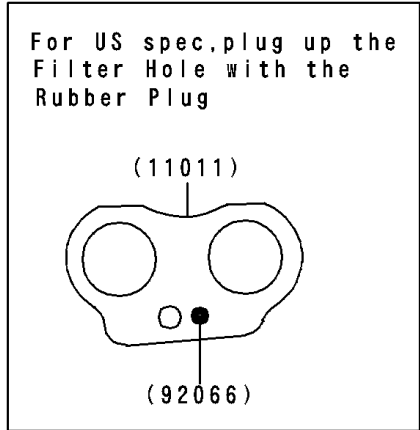
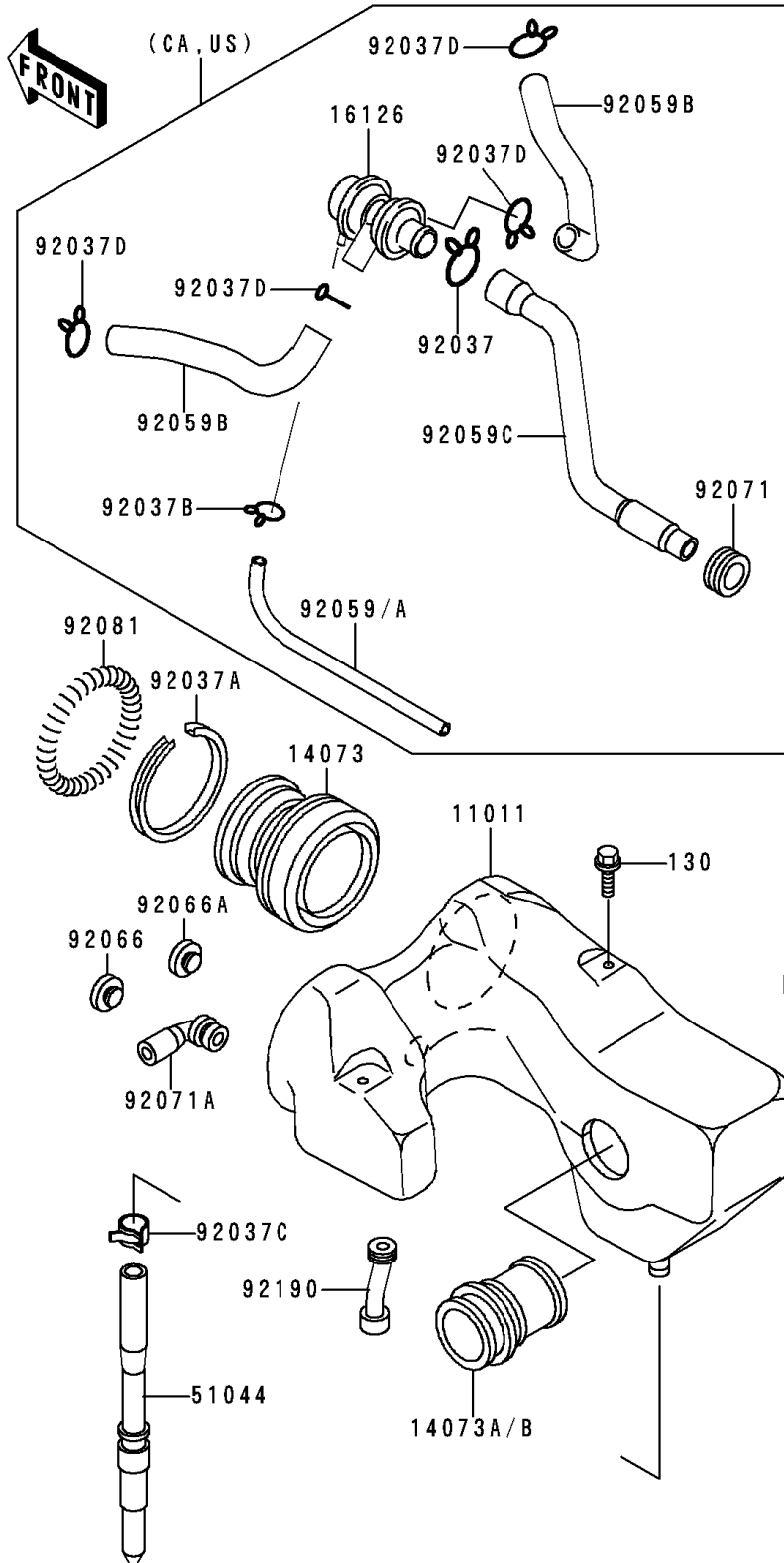

# 1993 Vulcan 500 PARTS LIST

## Air Cleaner

ITEM NAME	PART NUMBER	QUANTITY
BOLT-FLANGED (Ref # 130)	130D0610	2
BOLT-FLANGED (Ref # 130A)	130D0612	3
CASE-AIR FILTER (Ref # 11011)	11011-1331	1
CAP,AIR FILTER (Ref # 11012)	11012-1727	1
ELEMENT-AIR FILTER (Ref # 11013)	11013-1185	1
DUCT,CARBURETOR (Ref # 14073)	14073-1413	2
TUBE-ASSY,DRAIN (Ref # 51044)	51044-1084	1
CLAMP,69MM (Ref # 92037A)	92037-1631	2
CLAMP (Ref # 92037C)	92037-1861	1
SPRING,COIL,BLACK (Ref # 92081)	92081-1457	2
TUBE,BREATHER (Ref # 92190)	92190-1071	1
DUCT,AIR INTAKE (Ref # 14073A)	14073-1425	1
DUCT,AIR INTAKE (Ref # 14073B)	14073-1439	1
VALVE,AIR SWITCH (Ref # 16126)	16126-1014	1
CLAMP,TUBE (Ref # 92037)	92037-1076	1
CLAMP (Ref # 92037B)	92037-1712	1
CLAMP,TUBE (Ref # 92037D)	92037-213	4
TUBE,4X9X220 (Ref # 92059)	92059-1040	1
TUBE,4X9X290 (Ref # 92059A)	92059-1043	1
TUBE,AIR SWITCH VALVE (Ref # 92059B)	92059-1529	2
TUBE,AIR SWITCH VALVE (Ref # 92059C)	92059-1530	1
PLUG,17MM (Ref # 92066)	92066-1320	1
PLUG,25MM (Ref # 92066A)	92066-1321	1
GROMMET,AIR FILTER (Ref # 92071)	92071-1028	1
GROMMET,AIR FILTER (Ref # 92071A)	92071-1114	1