

1992 Vulcan 500 PARTS DIAGRAM

Crankcase Bolt Pattern

E1412

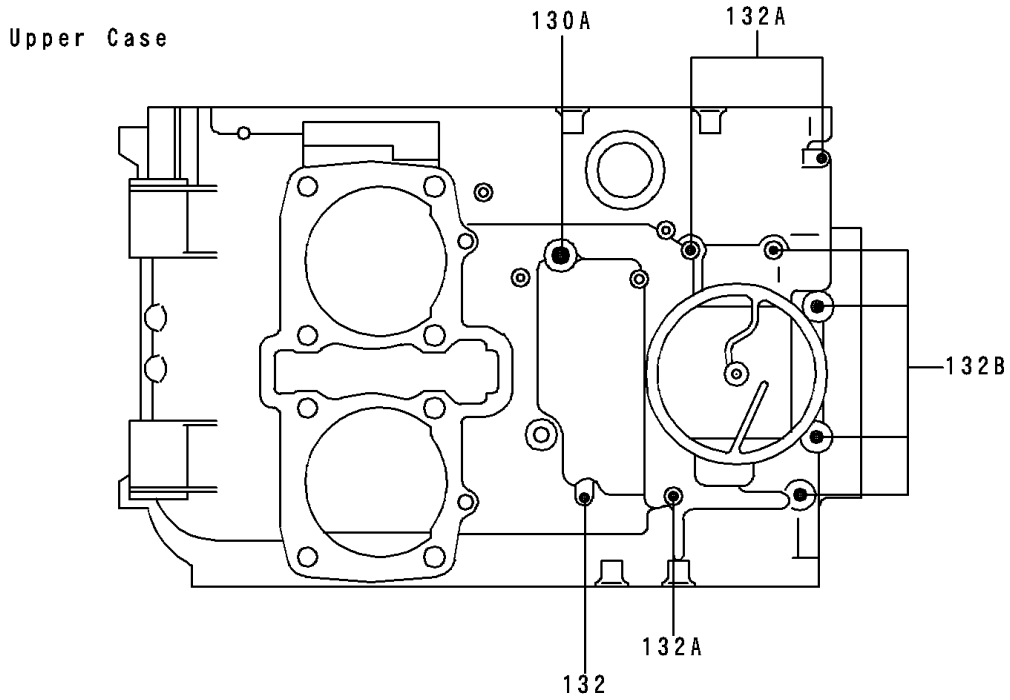

Lower Case

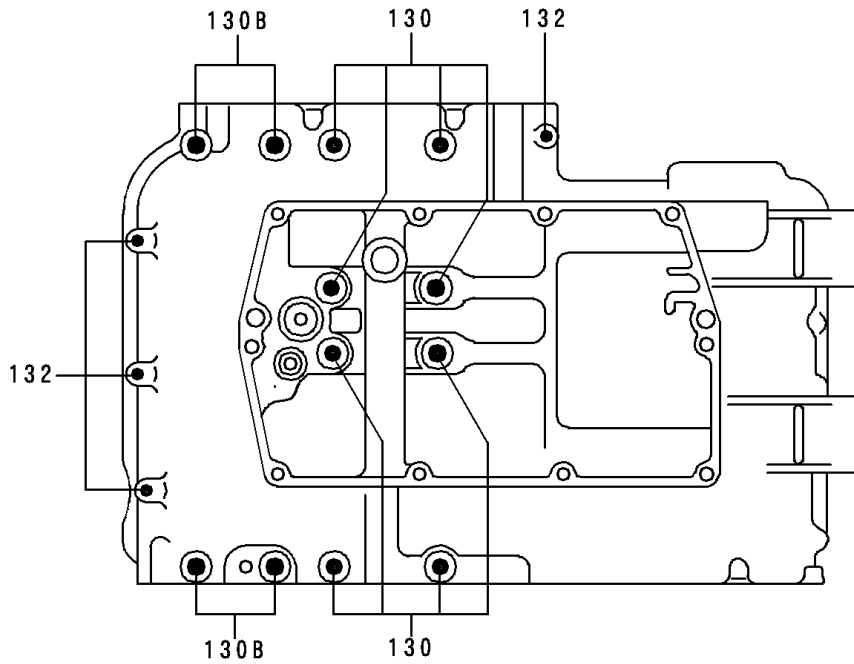

1992 Vulcan 500 PARTS LIST

Crankcase Bolt Pattern

ITEM NAME	PART NUMBER	QUANTITY
BOLT-FLANGED (Ref # 130)	130Z08100	8
BOLT-FLANGED (Ref # 130A)	130Z0855	1
BOLT-FLANGED (Ref # 130B)	130Z0875	4
BOLT-FLANGED-SMALL (Ref # 132)	132Y0640	5
BOLT-FLANGED-SMALL (Ref # 132A)	132Y0660	3
BOLT-FLANGED-SMALL (Ref # 132B)	132Y0680	4