

1992 Vulcan 500 PARTS DIAGRAM

Footrests

F2160

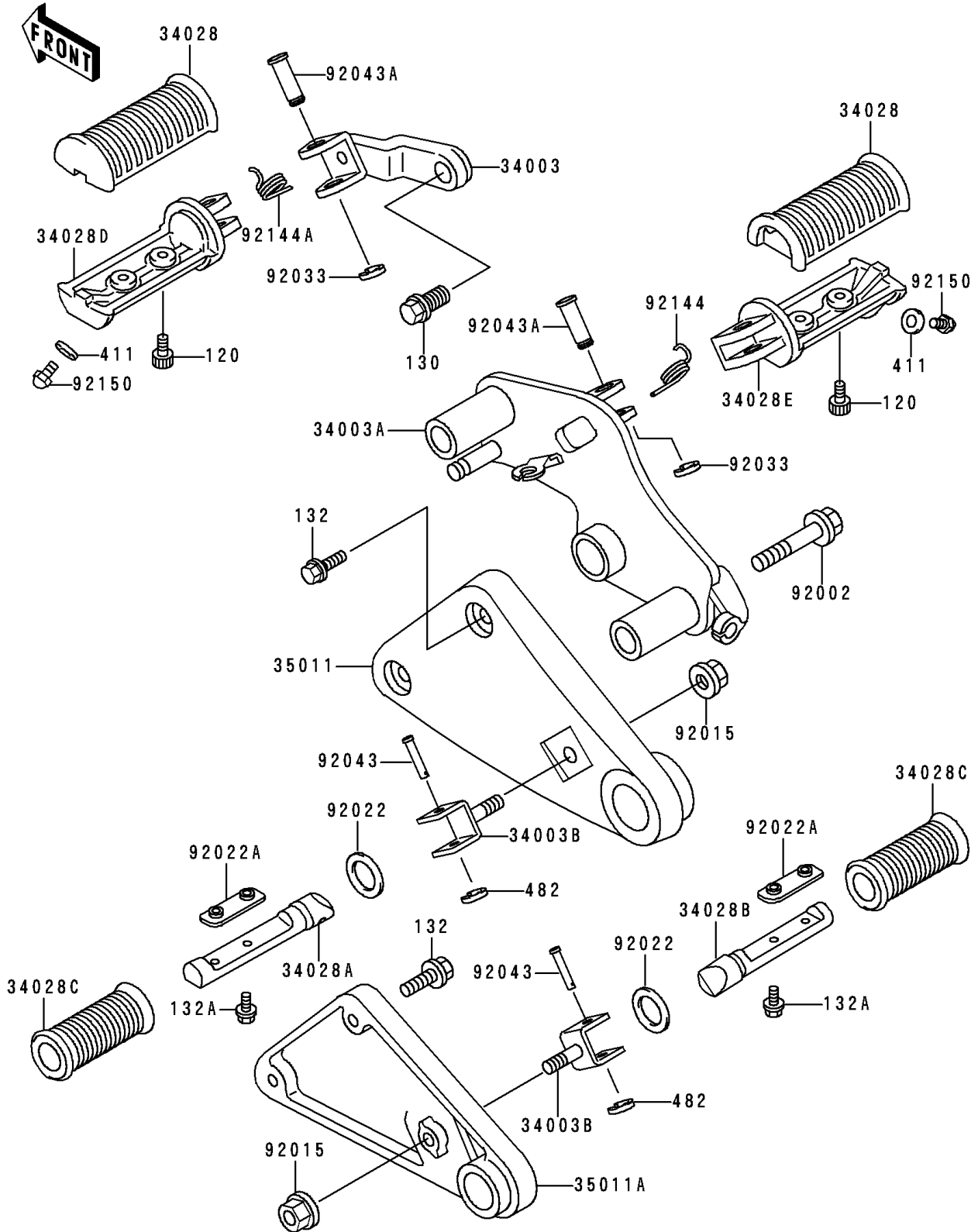

1992 Vulcan 500 PARTS LIST

Footrests

ITEM NAME	PART NUMBER	QUANTITY
BOLT-SOCKET (Ref # 120)	120S0512	4
BOLT-FLANGED (Ref # 130)	130J1230	1
BOLT-FLANGED-SMALL (Ref # 132)	132E0825	4
BOLT-FLANGED-SMALL (Ref # 132A)	132J0510	4
WASHER-PLAIN,6MM,BLACK (Ref # 411)	411F0600	2
CIRCLIP-TYPE-E (Ref # 482)	482L7000	2
HOLDER-STEP,FR,LH (Ref # 34003)	34003-1337	1
HOLDER-STEP,FR,RH (Ref # 34003A)	34003-1338	1
HOLDER-STEP,RR (Ref # 34003B)	34003-1347	2
STEP,FR,RUBBER (Ref # 34028)	34028-1217	2
STEP,RR,LH (Ref # 34028A)	34028-1219	1
STEP,RR,RH (Ref # 34028B)	34028-1220	1
STEP,RR,RUBBER (Ref # 34028C)	34028-1221	2
STEP,FR,LH (Ref # 34028D)	34028-1245	1
STEP,FR,RH (Ref # 34028E)	34028-1246	1
STAY,REAR STEP,LH (Ref # 35011)	35011-1523	1
STAY,REAR STEP,RH (Ref # 35011A)	35011-1524	1
BOLT,FLANGED,10X53.5 (Ref # 92002)	92002-1529	2
NUT,FLANGED,10MM (Ref # 92015)	92015-1428	2
WASHER,20X30X2.3 (Ref # 92022)	92022-1568	2
WASHER,STEP (Ref # 92022A)	92022-1874	2
RING-SNAP,10MM (Ref # 92033)	92033-1166	2
PIN,8X36.5 (Ref # 92043)	92043-1339	2
PIN,12X37 (Ref # 92043A)	92043-1358	2
SPRING,STEP RETURN (Ref # 92144)	92144-1126	1
SPRING,STEP RETURN (Ref # 92144A)	92144-1210	1
BOLT,BANK SENSOR (Ref # 92150)	92150-1114	2