

1993 Vulcan 500 PARTS DIAGRAM

Tires

F2210

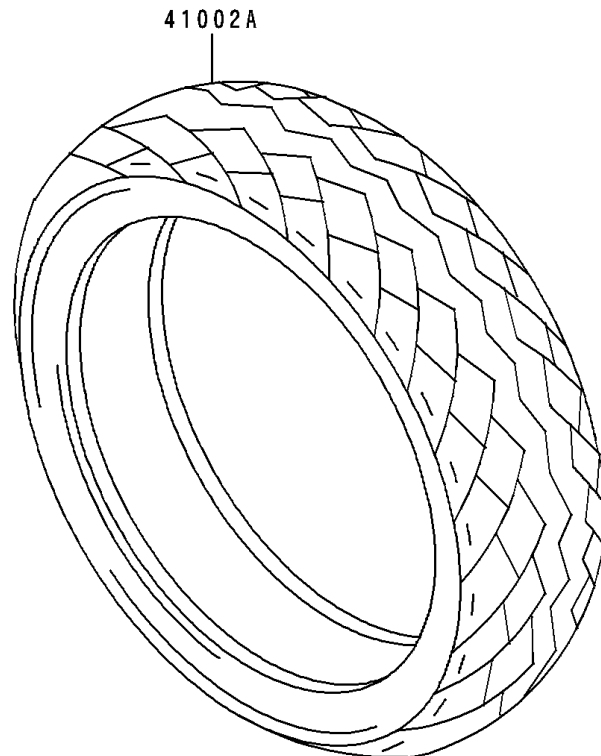
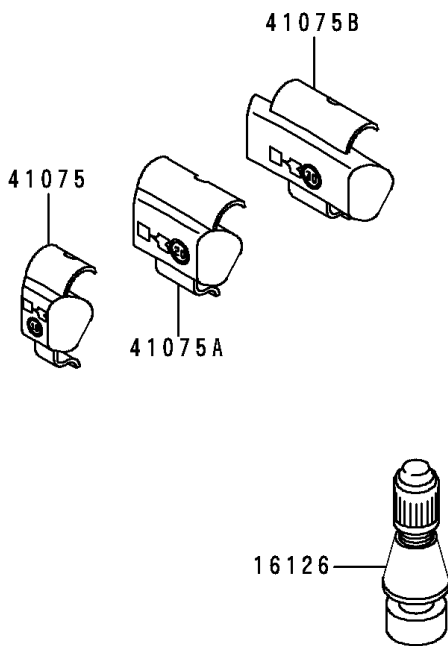
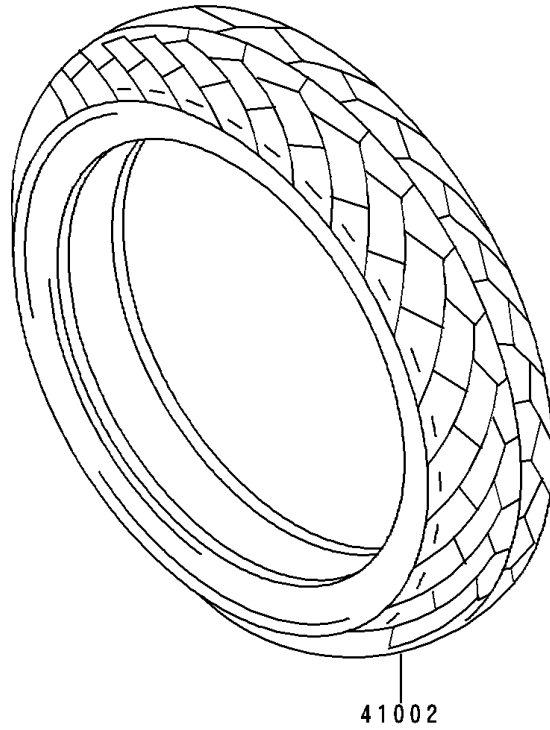
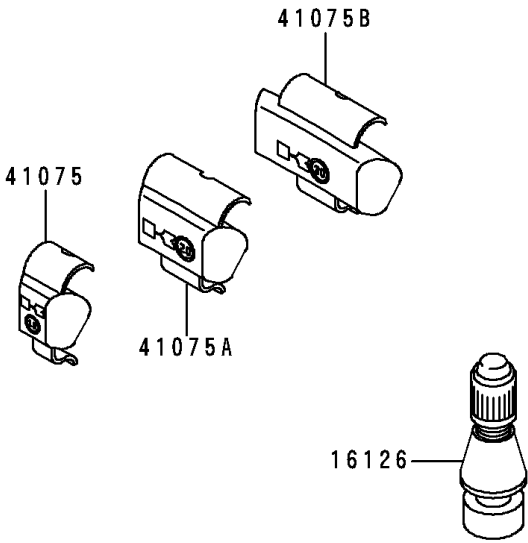

1993 Vulcan 500 PARTS LIST

Tires

ITEM NAME	PART NUMBER	QUANTITY
VALVE,TIRE (Ref # 16126)	16126-1140	2
TIRE,FR,100/90-19 57S,G523(BS) (Ref # 41002)	41002-1527	1
TIRE,RR,140/90-15 M/C 70S,G524 (Ref # 41002A)	41002-1728	1
BALANCER-WHEEL,10G,SILVER (Ref # 41075)	41075-1014	AR
BALANCER-WHEEL,20G,SILVER (Ref # 41075A)	41075-1015	AR
BALANCER-WHEEL,30G,SILVER (Ref # 41075B)	41075-1016	AR