

1992 Vulcan 500 PARTS DIAGRAM

Rear Wheel/Chain/Coupling

F2240

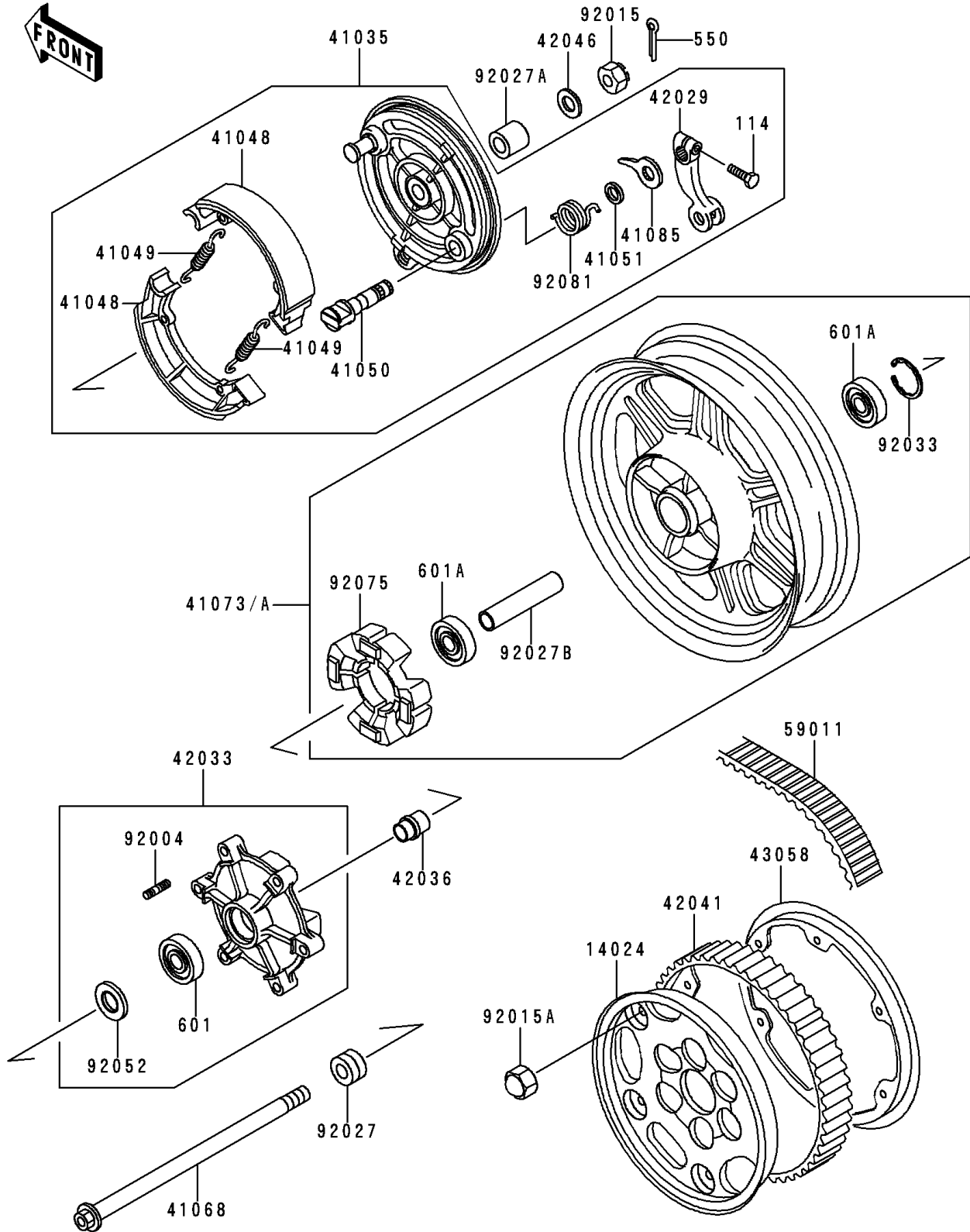

1992 Vulcan 500 PARTS LIST

Rear Wheel/Chain/Coupling

ITEM NAME	PART NUMBER	QUANTITY
BOLT-SMALL,8X28 (Ref # 114)	114G0828	1
PIN-COTTER,4.0X35 (Ref # 550)	550D4035	1
BEARING-BALL,#6205G (Ref # 601)	601B6205G	1
BEARING-BALL,#6303ZZC3 (Ref # 601A)	601B6303ZZ	2
COVER,HUB SPROCKET,OUTSIDE (Ref # 14024)	14024-1873	1
PANEL-ASSY-BRAKE,RR (Ref # 41035)	41035-1277	1
SHOE-BRAKE (Ref # 41048)	41048-1070	2
SPRING,BRAKE SHOE (Ref # 41049)	41049-012	2
CAM-BRAKE (Ref # 41050)	41050-017	1
SEAL,BRAKE CAM (Ref # 41051)	41051-003	1
AXLE,RR (Ref # 41068)	41068-1205	1
WHEEL-ASSY,RR,C.GRAY+CLEAR (Ref # 41073A)	41073-1493-JD	1
INDICATOR (Ref # 41085)	41085-1054	1
LEVER-BRAKE CAM (Ref # 42029)	42029-039	1
COUPLING-ASSY,RR HUB (Ref # 42033)	42033-1138	1
SLEEVE,RR HUB,L=33 (Ref # 42036)	42036-1146	1
SPROCKET-HUB,68T (Ref # 42041)	42041-1195	1
WASHER,17.3X32X3.2 (Ref # 42046)	42046-009	1
RING,HUB SPROCKET (Ref # 43058)	43058-1054	1
BELT,DRIVE,137T (Ref # 59011)	59011-1012	1
STUD,10X27 (Ref # 92004)	92004-1145	6
NUT,16MM (Ref # 92015)	92015-055	1
NUT,CAP,10MM (Ref # 92015A)	92015-1685	6
COLLAR,REAR AXLE,LH,L=23.5 (Ref # 92027)	92027-1368	1
COLLAR,REAR AXLE,RH,L=18.5 (Ref # 92027A)	92027-1484	1
COLLAR,17.2X25X101 (Ref # 92027B)	92027-1863	1
RING-SNAP,47MM (Ref # 92033)	92033-1042	1
SEAL-OIL,TWC35527 (Ref # 92052)	92052-006	1
DAMPER,SHOCK,RR HUB (Ref # 92075)	92075-1687	1

1992 Vulcan 500 PARTS LIST

Rear Wheel/Chain/Coupling

ITEM NAME	PART NUMBER	QUANTITY
SPRING,BRAKE CAM LEVER RETURN (Ref # 92081)	92081-1814	1