

1994 Vulcan 500 PARTS DIAGRAM

Front Fork

F2340

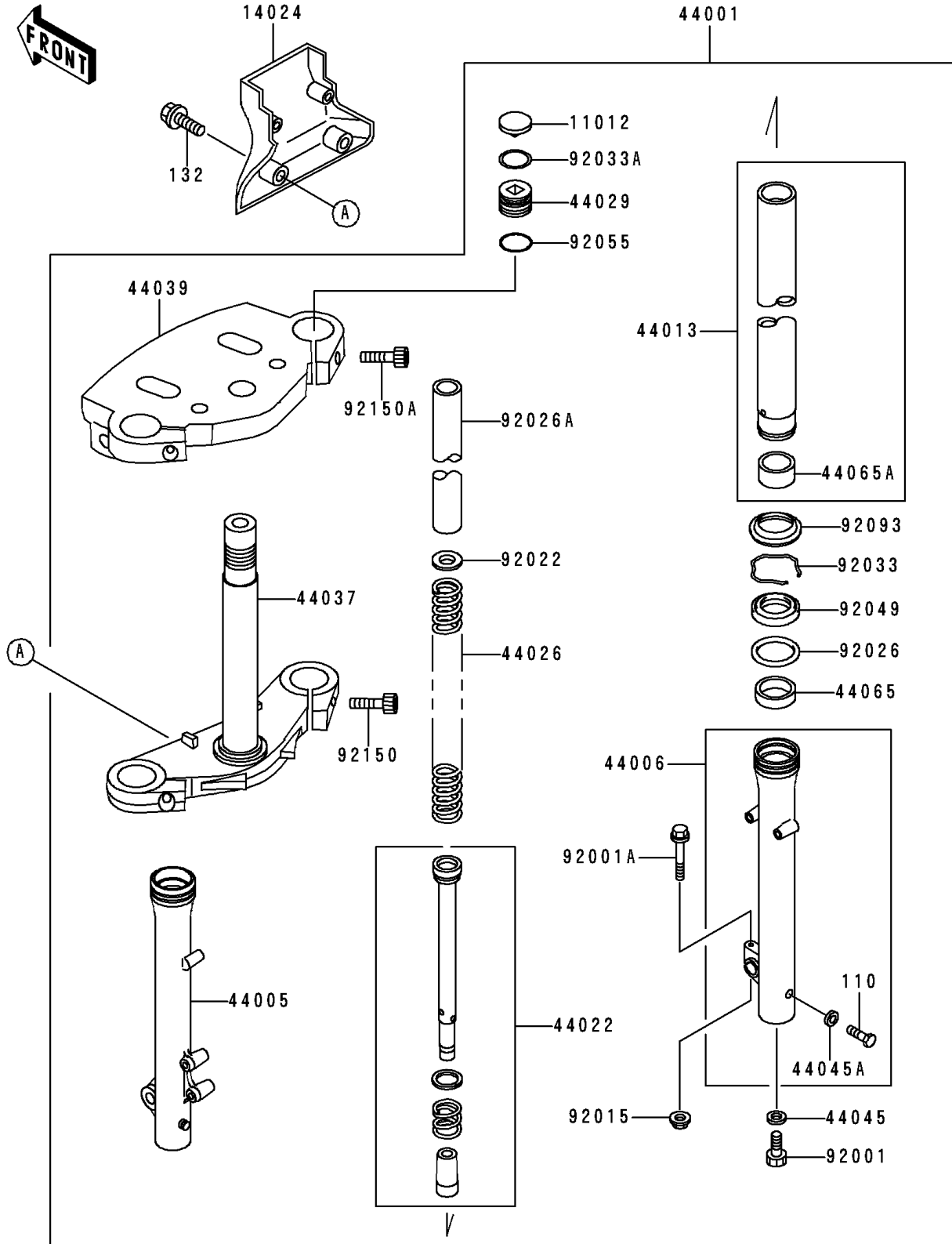

1994 Vulcan 500 PARTS LIST

Front Fork

ITEM NAME	PART NUMBER	QUANTITY
BOLT,6X8 (Ref # 110)	110B0608	2
BOLT-FLANGED-SMALL (Ref # 132)	132E0625	2
CAP,FORK TOP (Ref # 11012)	11012-1689	2
COVER (Ref # 14024)	14024-1900	1
FORK-FRONT (Ref # 44001)	44001-1752	1
PIPE-LEFT FORK OUTER (Ref # 44005)	44005-1230	1
PIPE-RIGHT FORK OUTER (Ref # 44006)	44006-1230	1
PIPE-FORK INNER (Ref # 44013)	44013-1286	2
CYLINDER-FORK (Ref # 44022)	44022-1178	2
SPRING-FRONT FORK (Ref # 44026)	44026-1464	2
SEAT-FORK SPRING (Ref # 44029)	44029-1124	2
HOLDER-FORK UNDER (Ref # 44037)	44037-1265	1
HOLDER-FORK UPPER (Ref # 44039)	44039-1198	1
GASKET,FORK CYLINDER BOLT (Ref # 44045)	44045-051	2
GASKET,DRAIN PLUG (Ref # 44045A)	44045-052	2
BUSHING-FRONT FORK (Ref # 44065)	44065-1068	2
BUSHING-FRONT FORK,INNER PIPE (Ref # 44065A)	44065-1069	2
BOLT,FORK CYLINDER (Ref # 92001)	92001-1464	2
BOLT,FLANGED,8X50 (Ref # 92001A)	92001-1486	1
NUT,FLANGED,8MM (Ref # 92015)	92015-1055	1
WASHER (Ref # 92022)	92022-1702	2
SPACER,FORK (Ref # 92026)	92026-1038	2
SPACER (Ref # 92026A)	92026-1392	2
RING-SNAP,FORK (Ref # 92033)	92033-1193	2
RING-SNAP,FORK TOP (Ref # 92033A)	92033-1220	2
SEAL-OIL,FORK (Ref # 92049)	92049-1226	2
RING-O,FORK SPRING SEAT (Ref # 92055)	92055-1359	2
SEAL,FORK (Ref # 92093)	92093-1196	2
BOLT,SOCKET,10X25 (Ref # 92150)	92150-1387	2

1994 Vulcan 500 PARTS LIST

Front Fork

ITEM NAME	PART NUMBER	QUANTITY
BOLT,SOCKET,8X30 (Ref # 92150A)	92150-1407	2