

1991 Vulcan 500 PARTS DIAGRAM

Taillight

F2720

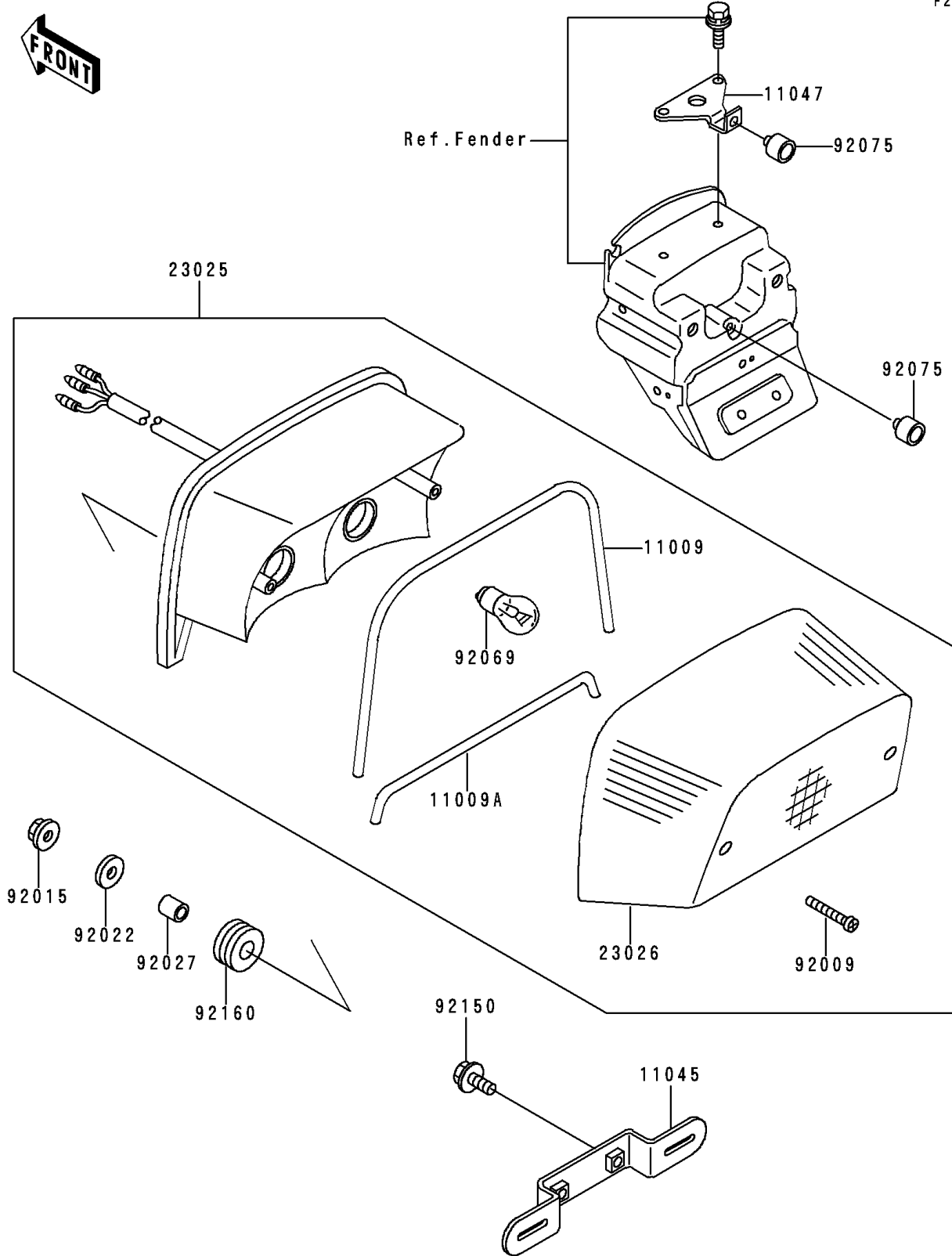

1991 Vulcan 500 PARTS LIST

Taillight

ITEM NAME	PART NUMBER	QUANTITY
GASKET,TAIL LAMP LENS (Ref # 11009)	11009-1811	1
GASKET,TAIL LAMP LENS (Ref # 11009A)	11009-1812	1
BRACKET,LICENSE (Ref # 11045)	11045-1387	1
BRACKET,REAR FENDER (Ref # 11047)	11047-1074	1
LAMP-TAIL (Ref # 23025)	23025-1199	1
LENS,TAIL LAMP (Ref # 23026)	23026-1122	1
SCREW,TAPPING,4X30 (Ref # 92009)	92009-1506	2
NUT,FLANGED,6MM (Ref # 92015)	92015-1367	2
WASHER,6.5X20X1.6 (Ref # 92022)	92022-1557	2
COLLAR,6.8X10X12 (Ref # 92027)	92027-162	2
BULB,12V 27/8W (Ref # 92069)	92069-059	2
DAMPER (Ref # 92075)	92075-035	2
BOLT,6X14 (Ref # 92150)	92150-1133	2
DAMPER (Ref # 92160)	92160-1162	2