

1998 Vulcan 500 LTD PARTS DIAGRAM

Cylinder Head Cover

E1112

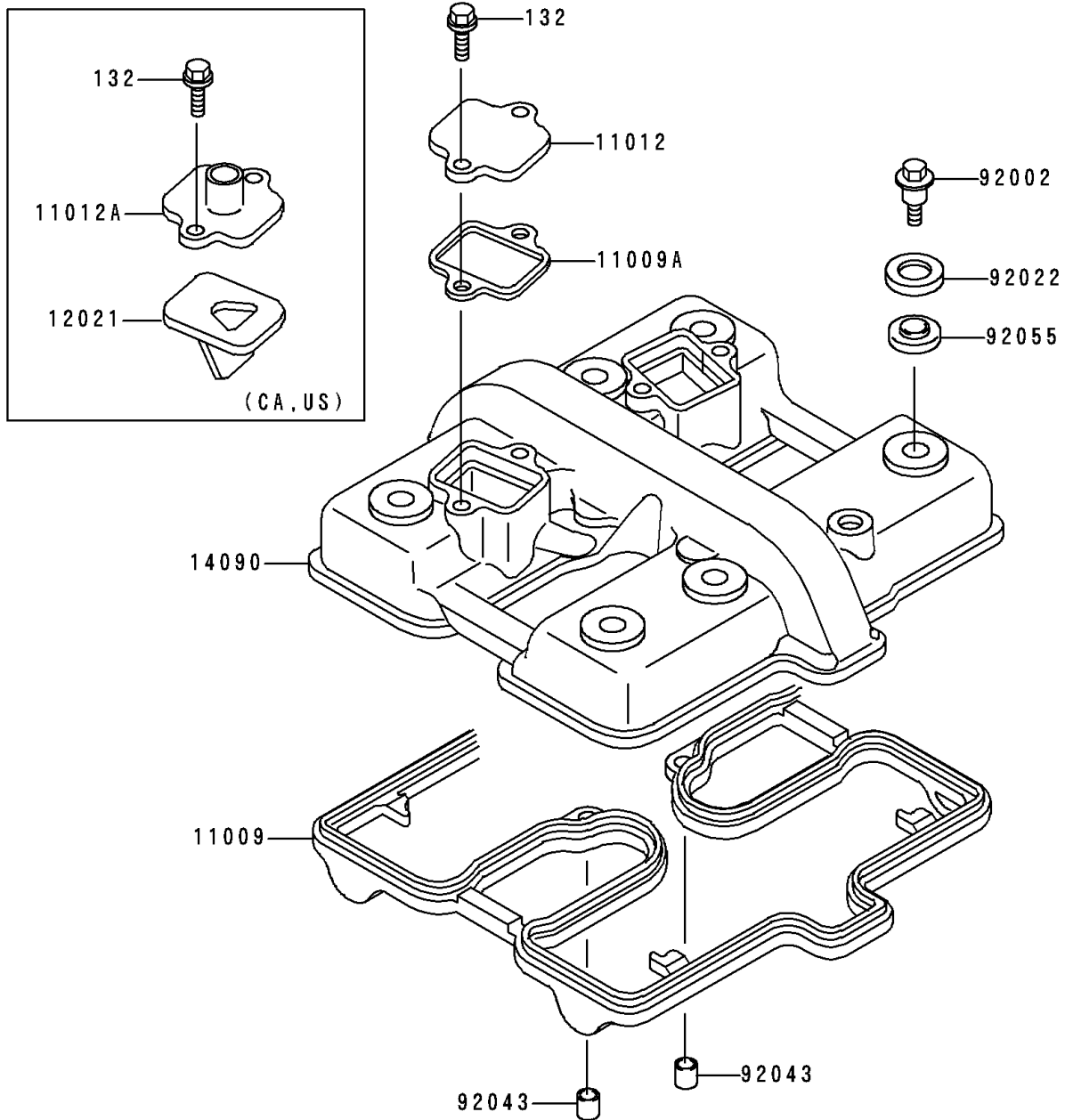

1998 Vulcan 500 LTD PARTS LIST

Cylinder Head Cover

ITEM NAME	PART NUMBER	QUANTITY
BOLT-FLANGED-SMALL (Ref # 132)	132Y0616	4
GASKET,CYLINDER HEAD COVER (Ref # 11009)	11009-1483	1
CAP,REED VALVE (Ref # 11012A)	11012-1949	2
VALVE-ASSY-REED (Ref # 12021)	12021-1026	2
COVER,HEAD (Ref # 14090)	14090-1660	1
BOLT (Ref # 92002)	92002-1595	6
WASHER,HEAD COVER BOLT (Ref # 92022)	92022-1637	6
PIN,DOWEL,8X10 (Ref # 92043)	92043-1302	2
RING-O,HEAD COVER BOLT (Ref # 92055)	92055-1225	6