

1999 Vulcan 500 LTD PARTS DIAGRAM

Rear Wheel/Chain

F2240

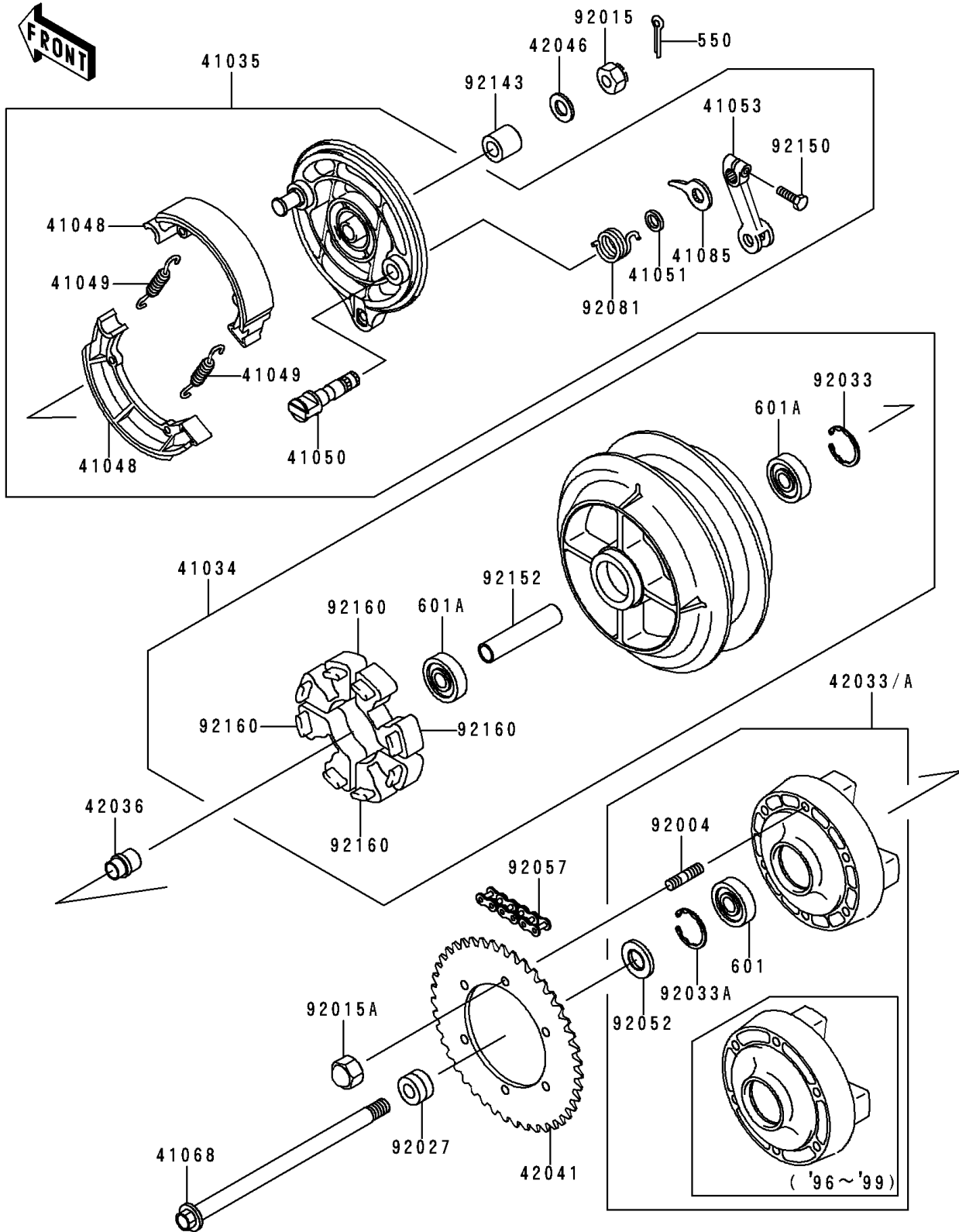

1999 Vulcan 500 LTD PARTS LIST

Rear Wheel/Chain

ITEM NAME	PART NUMBER	QUANTITY
PIN-COTTER,4.0X35 (Ref # 550)	550D4035	1
BEARING-BALL,#6205UG (Ref # 601)	601B6205UG	1
BEARING-BALL,#6303UUC3 (Ref # 601A)	601B6303UU	2
DRUM-ASSY,REAR BRAKE (Ref # 41034)	41034-1258	1
PANEL-ASSY-BRAKE,RR (Ref # 41035)	41035-1485	1
SHOE-BRAKE (Ref # 41048)	41048-1070	2
SPRING,BRAKE SHOE (Ref # 41049)	41049-012	2
CAM-BRAKE (Ref # 41050)	41050-1059	1
SEAL,BRAKE CAM (Ref # 41051)	41051-003	1
LEVER-BRAKE CAM (Ref # 41053)	41053-1072	1
AXLE,RR (Ref # 41068)	41068-1377	1
INDICATOR (Ref # 41085)	41085-1054	1
COUPLING-ASSY,RR HUB (Ref # 42033)	42033-1100	1
SLEEVE,RR HUB,L=28 (Ref # 42036)	42036-1328	1
SPROCKET-HUB,42T (Ref # 42041)	42041-1474	1
WASHER,17.3X32X3.2 (Ref # 42046)	42046-009	1
STUD,10X19 (Ref # 92004)	92004-1151	6
NUT,CASTLE,16MM (Ref # 92015)	92015-1951	1
NUT,CAP,10MM (Ref # 92015A)	92015-1961	6
COLLAR,REAR AXLE,LH,L=23.5 (Ref # 92027)	92027-1368	1
RING-SNAP,47MM (Ref # 92033)	92033-1042	1
RING-SNAP,52MM (Ref # 92033A)	92033-1043	1
SEAL-OIL,TWC35527 (Ref # 92052)	92052-006	1
CHAIN,DRIVE,EK520SX-OX110L (Ref # 92057)	92057-1423	1
SPRING,BRAKE CAM LEVER RETURN (Ref # 92081)	92081-1814	1
COLLAR,REAR AXLE,RH,L=33.5 (Ref # 92143)	92143-1898	1
BOLT,8X27 (Ref # 92150)	92150-1797	1
COLLAR,RR HUB,L=101 (Ref # 92152)	92152-1117	1
DAMPER,SHOCK,RR HUB (Ref # 92160)	92160-1697	4