

2001 Vulcan 500 LTD PARTS DIAGRAM

Cylinder/Piston(s)

E1120

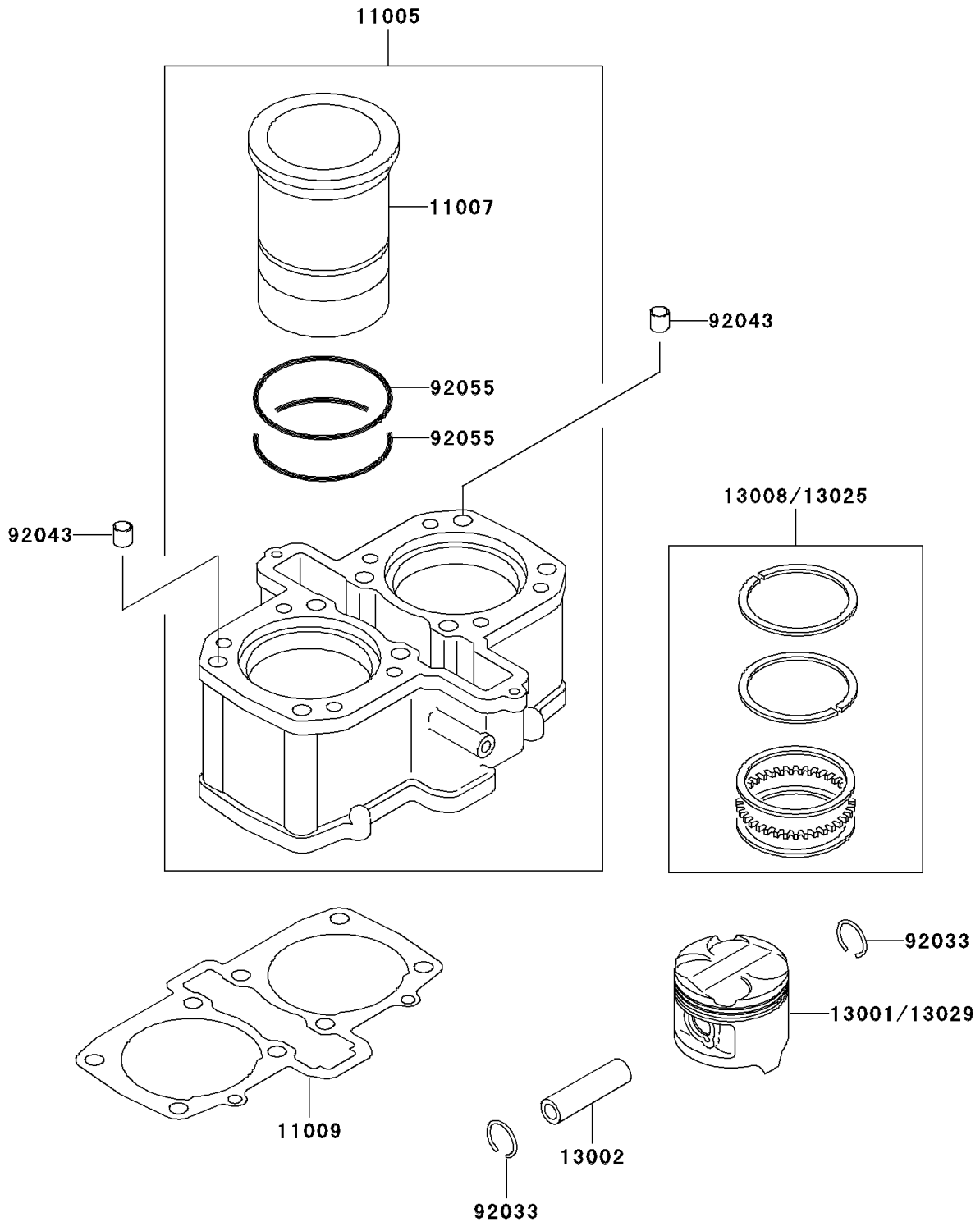

2001 Vulcan 500 LTD PARTS LIST

Cylinder/Piston(s)

ITEM NAME	PART NUMBER	QUANTITY
CYLINDER-ENGINE (Ref # 11005)	11005-1626	1
LINER-CYLINDER (Ref # 11007)	11007-1096	2
GASKET,CYLINDER BASE (Ref # 11009)	11009-1640	1
PISTON-ENGINE,STD (Ref # 13001)	13001-1452	2
PIN-PISTON (Ref # 13002)	13002-1058	2
RING-SET-PISTON,STD (Ref # 13008)	13008-1084	2
RING-SET-PISTON L,O/S 0.50 (Ref # 13025)	13025-1084	AR
PISTON-ENGINE L,O/S 0.50 (Ref # 13029)	13029-1231	AR
RING-SNAP,20.5X1.2 (Ref # 92033)	92033-1099	4
PIN,11.5X14X14 (Ref # 92043)	92043-1279	2
RING-O (Ref # 92055)	92055-1247	4