

2000 Ninja® 250R PARTS DIAGRAM

Oil Pump/Oil Filter

E1710

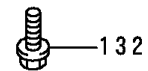
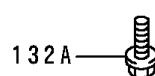
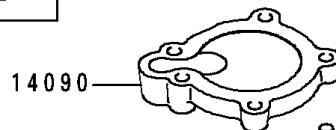
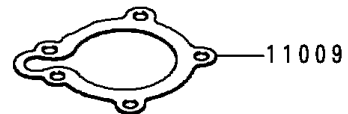
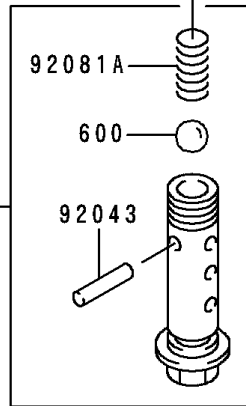
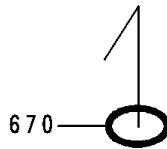
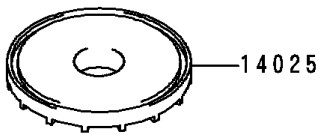
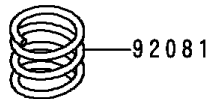
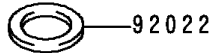
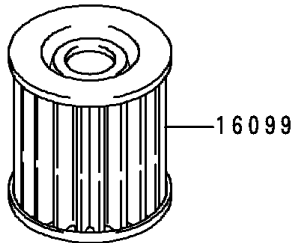
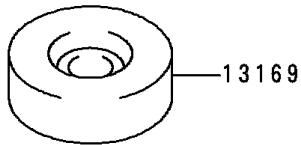
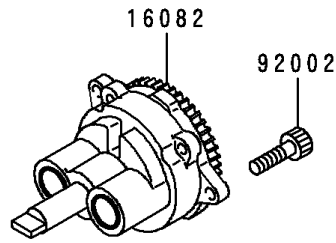
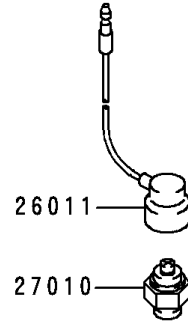
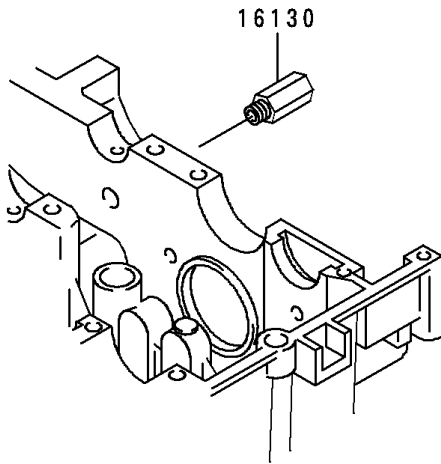

2000 Ninja® 250R PARTS LIST

Oil Pump/Oil Filter

| ITEM NAME | PART NUMBER | QUANTITY |
|--|-------------|----------|
| BOLT-FLANGED-SMALL (Ref # 132) | 132J0625 | 3 |
| BOLT-FLANGED-SMALL (Ref # 132A) | 132J0630 | 2 |
| BALL-STEEL,3/8" (Ref # 600) | 600A1200 | 1 |
| O RING,16MM (Ref # 670) | 670B2016 | 1 |
| O RING,90MM (Ref # 671) | 671B2590 | 1 |
| GASKET,OIL FILTER COVER (Ref # 11009) | 11009-1874 | 1 |
| PLATE,OIL FILTER (Ref # 13169) | 13169-1313 | 1 |
| COVER,OIL FILTER,F.BLACK (Ref # 14025) | 14025-1422 | 1 |
| COVER,OIL FILTER (Ref # 14090) | 14090-1350 | 1 |
| PUMP-ASSY-OIL (Ref # 16082) | 16082-1078 | 1 |
| ELEMENT-OIL FILTER (Ref # 16099) | 16099-003 | 1 |
| FILTER,OIL (Ref # 16111) | 16111-003 | 1 |
| VALVE,OIL FILTER (Ref # 16126) | 16126-1108 | 1 |
| VALVE-ASSY-RELIEF (Ref # 16130) | 16130-1001 | 1 |
| WIRE-LEAD (Ref # 26011) | 26011-1371 | 1 |
| SWITCH,OIL PRESSURE (Ref # 27010) | 27010-1313 | 1 |
| BOLT,SOCKET,6X25 (Ref # 92002) | 92002-1696 | 2 |
| WASHER,20.5X30X1 (Ref # 92022) | 92022-1012 | 1 |
| PIN,SPRING,2X20 (Ref # 92043) | 92043-111 | 1 |
| SPRING,OIL FILTER (Ref # 92081) | 92081-1018 | 1 |
| SPRING (Ref # 92081A) | 92081-109 | 1 |