

2004 Ninja® 250R PARTS DIAGRAM

Gear Change Drum/Shift Fork(s)

E1362

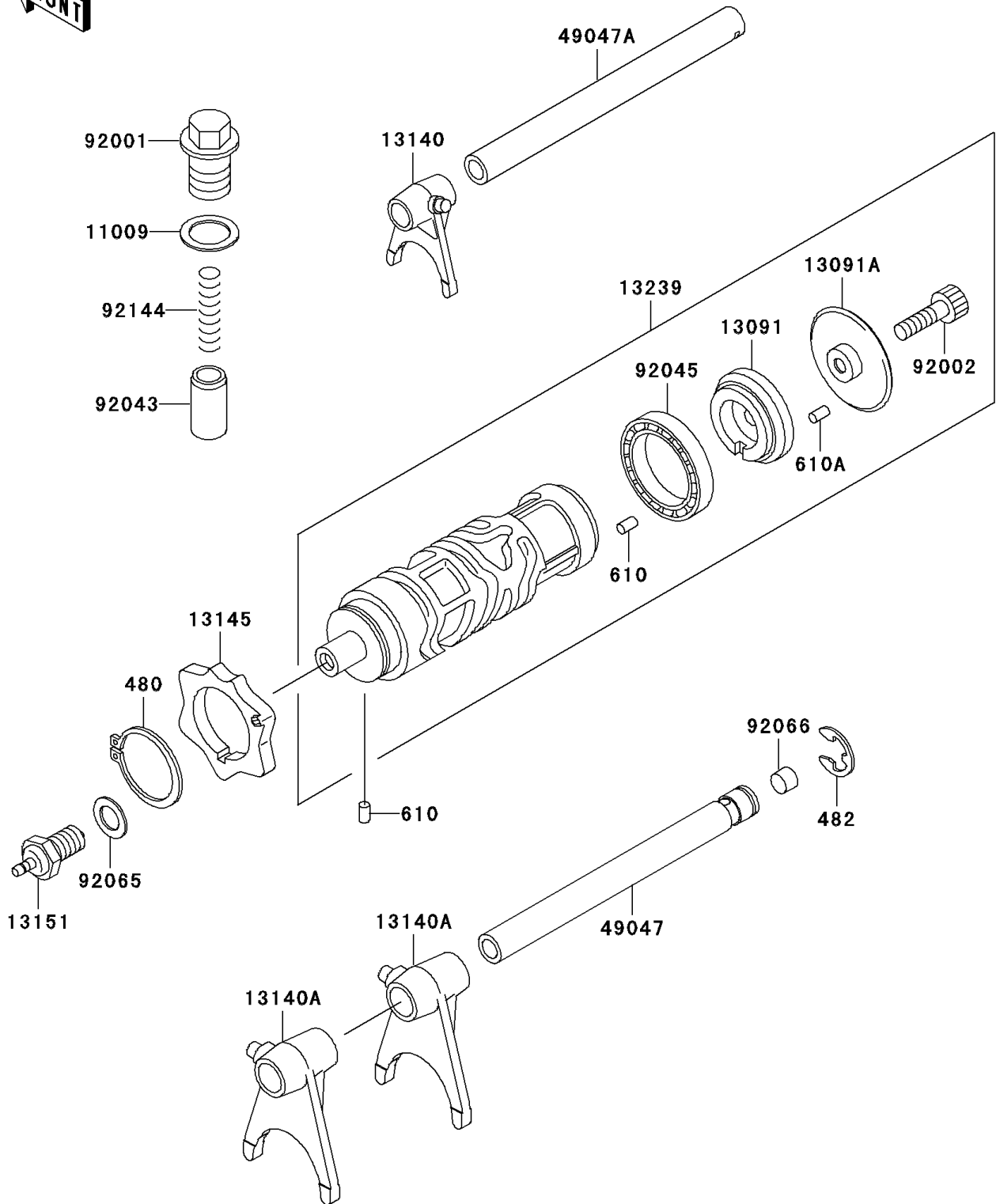

2004 Ninja® 250R PARTS LIST

Gear Change Drum/Shift Fork(s)

ITEM NAME	PART NUMBER	QUANTITY
CIRCLIP-TYPE-C,30MM (Ref # 480)	480J3000	1
CIRCLIP-TYPE-E,10MM (Ref # 482)	482J0100	1
ROLLER,4X6 (Ref # 610)	610A0406	2
ROLLER,4X8 (Ref # 610A)	610A0408	6
GASKET,15.5X22X1 (Ref # 11009)	11009-1008	1
HOLDER (Ref # 13091)	13091-1417	1
HOLDER,CHANGE DRUM (Ref # 13091A)	13091-1464	1
FORK-SHIFT,IN (Ref # 13140)	13140-1148	1
FORK-SHIFT,OUT (Ref # 13140A)	13140-1149	2
CAM-CHANGE DRUM (Ref # 13145)	13145-1058	1
SWITCH-COMP,NEUTRAL (Ref # 13151)	13151-1080	1
DRUM-ASSY-CHANGE (Ref # 13239)	13239-1131	1
ROD-SHIFT,OUT (Ref # 49047)	49047-1067	1
ROD-SHIFT (Ref # 49047A)	49047-1095	1
BOLT,NEUTRAL POSITION (Ref # 92001)	92001-1037	1
BOLT,SOCKET,6X25 (Ref # 92002)	92002-1696	1
PIN (Ref # 92043)	92043-076	1
BEARING-BALL,6806 (Ref # 92045)	92045-1152	1
GASKET,10.5X16X1 (Ref # 92065)	92065-058	1
PLUG (Ref # 92066)	92066-1246	1
SPRING,NEUTRAL POSITION (Ref # 92144)	92144-1580	1