

2005 Ninja® 250R PARTS DIAGRAM

Suspension/Shock Absorber

F2151

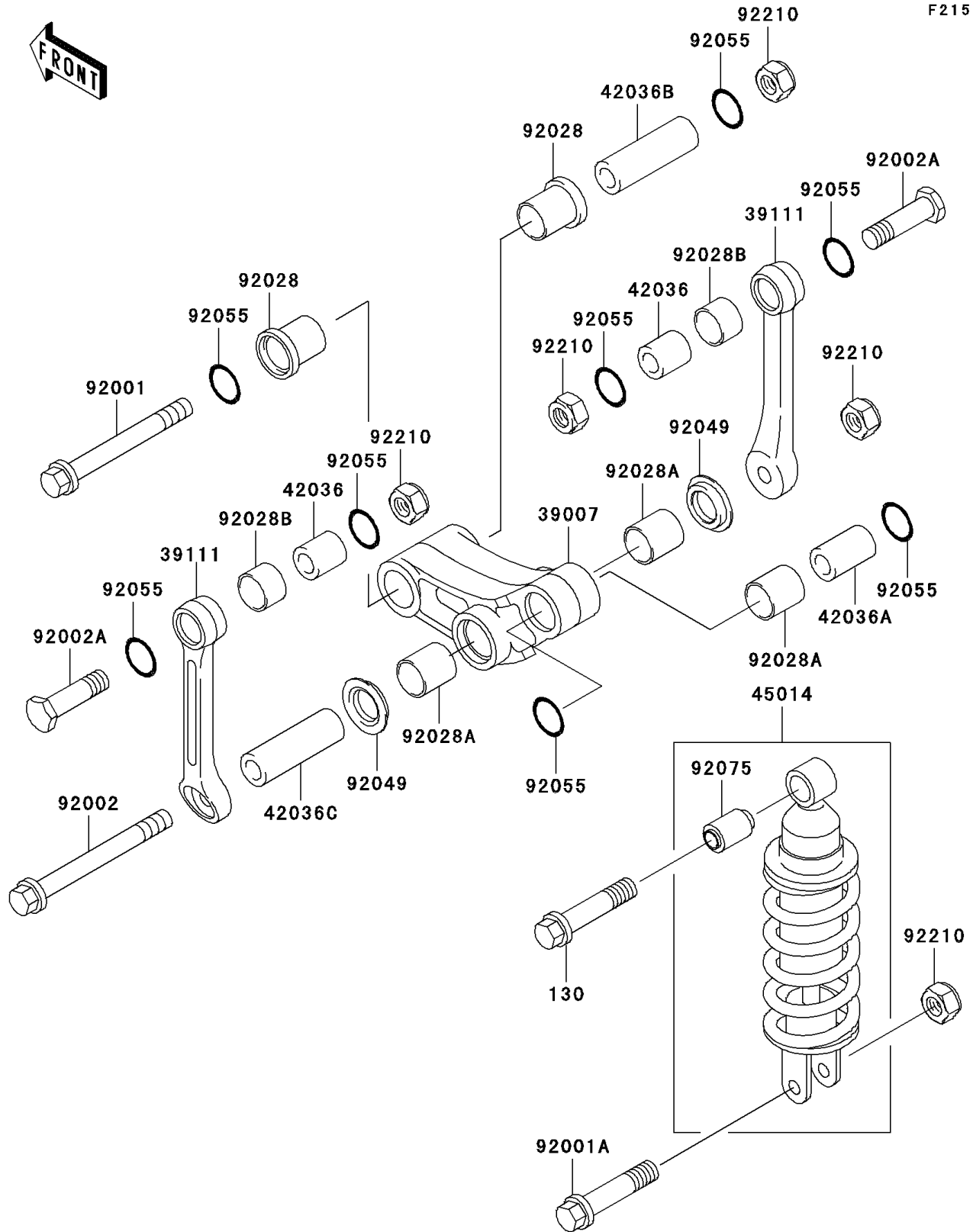

2005 Ninja® 250R PARTS LIST

Suspension/Shock Absorber

ITEM NAME	PART NUMBER	QUANTITY
BOLT-FLANGED,12X55 (Ref # 130)	130G1255	1
ARM-SUSP,UNI TRAK (Ref # 39007)	39007-1093	1
ROD-TIE,UNI TRAK (Ref # 39111)	39111-1021	2
SLEEVE,12.1X20X22 (Ref # 42036)	42036-1076	2
SLEEVE,12.1X20X32 (Ref # 42036A)	42036-1077	1
SLEEVE,ARM,FR (Ref # 42036B)	42036-1078	1
SLEEVE,12.1X20X70 (Ref # 42036C)	42036-1079	1
SHOCKABSORBER (Ref # 45014)	45014-1406	1
BOLT,12X90 (Ref # 92001)	92001-1937	1
BOLT,12X55 (Ref # 92001A)	92001-1938	1
BOLT,12X110 (Ref # 92002)	92002-1064	1
BOLT,12X45 (Ref # 92002A)	92002-1065	2
BUSHING (Ref # 92028)	92028-1597	2
BUSHING (Ref # 92028A)	92028-1598	3
BUSHING (Ref # 92028B)	92028-1599	2
SEAL-OIL,ARM (Ref # 92049)	92049-1109	2
RING-O,19.8X2.2 (Ref # 92055)	92055-1215	8
DAMPER,SHOCKABSORBER (Ref # 92075)	92075-1497	1
NUT,LOCK,12MM (Ref # 92210)	92210-1247	5