

1992 Ninja® 250R PARTS DIAGRAM

Gear Change Mechanism

E1370

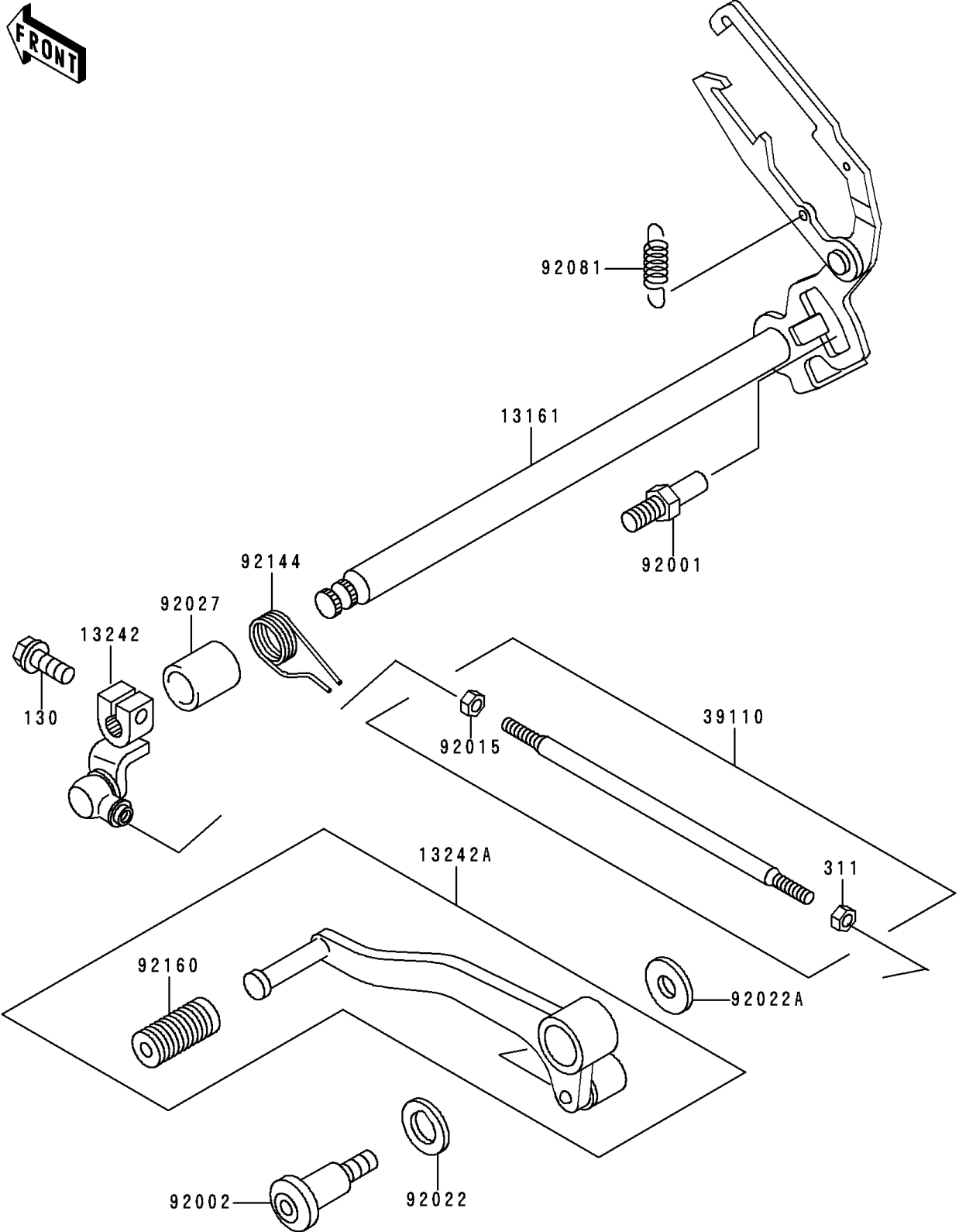

1992 Ninja® 250R PARTS LIST

Gear Change Mechanism

ITEM NAME	PART NUMBER	QUANTITY
-----------	-------------	----------