

1994 Ninja® 250R PARTS DIAGRAM

Gear Change Mechanism

E1370

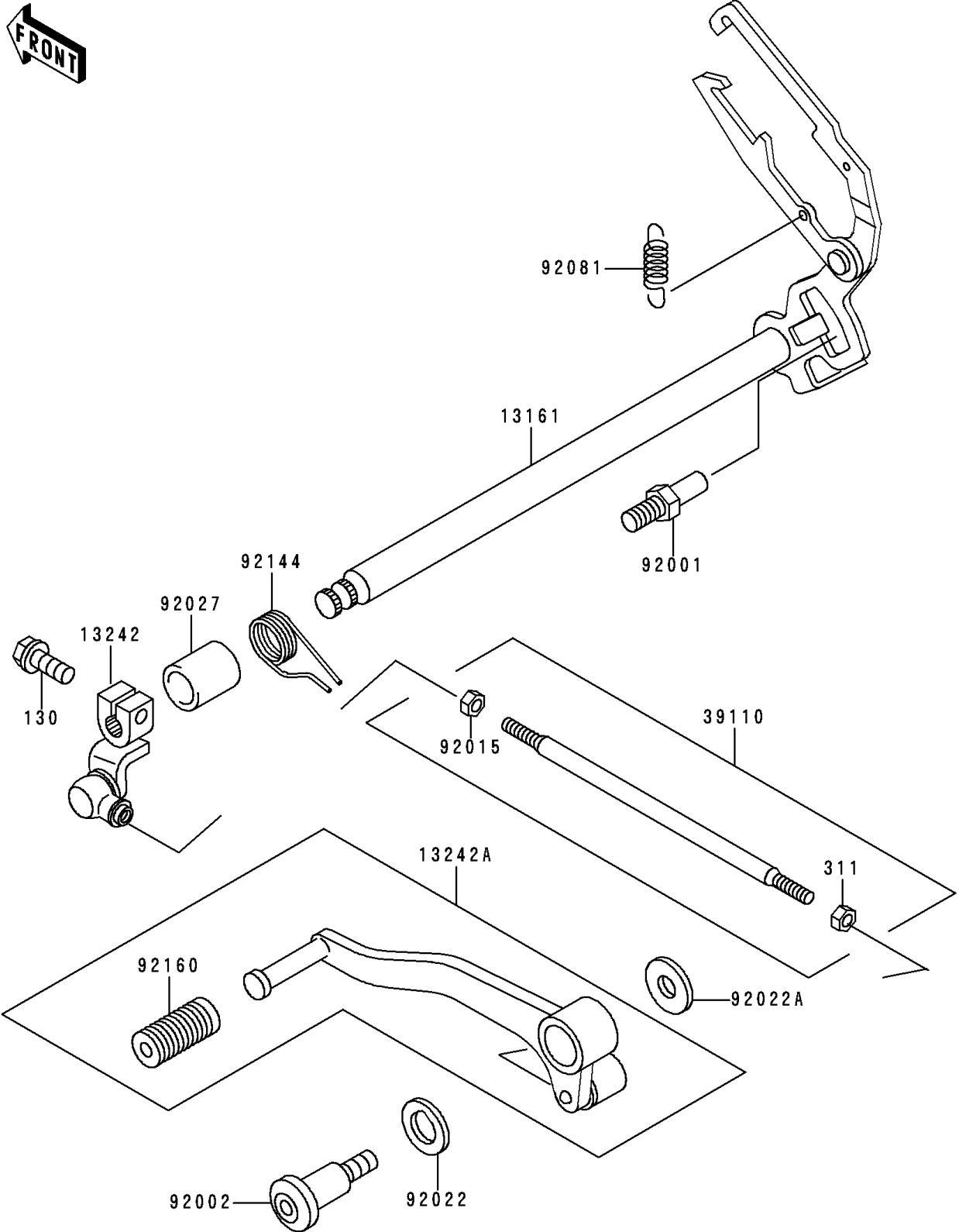

1994 Ninja® 250R PARTS LIST

Gear Change Mechanism

ITEM NAME	PART NUMBER	QUANTITY
BOLT-FLANGED,6X20,BLACK (Ref # 130)	130S0620	1
NUT-HEX (Ref # 311)	311J0600	1
LEVER-COMP-CHANGE SHAFT (Ref # 13161)	13161-1131	1
LEVER-ASSY-CHANGE (Ref # 13242)	13242-1214	1
LEVER-ASSY-CHANGE,PEDAL (Ref # 13242A)	13242-1215	1
ROD-ASSY-TIE (Ref # 39110)	39110-1075	1
BOLT,RETURN SPRING (Ref # 92001)	92001-1455	1
BOLT,CHANGE PEDAL (Ref # 92002)	92002-1926	1
NUT (Ref # 92015)	92015-1178	1
WASHER,12.5X21X1.2 (Ref # 92022)	92022-072	1
WASHER,8.5X20X1.6 (Ref # 92022A)	92022-1561	1
COLLAR,13X18.3X21.5 (Ref # 92027)	92027-1440	1
SPRING,CHANGE LEVER (Ref # 92081)	92081-076	1
SPRING,CHANGE PEDAL RETURN (Ref # 92144)	92144-1074	1
DAMPER,CHANGE PEDAL (Ref # 92160)	92160-1036	1