

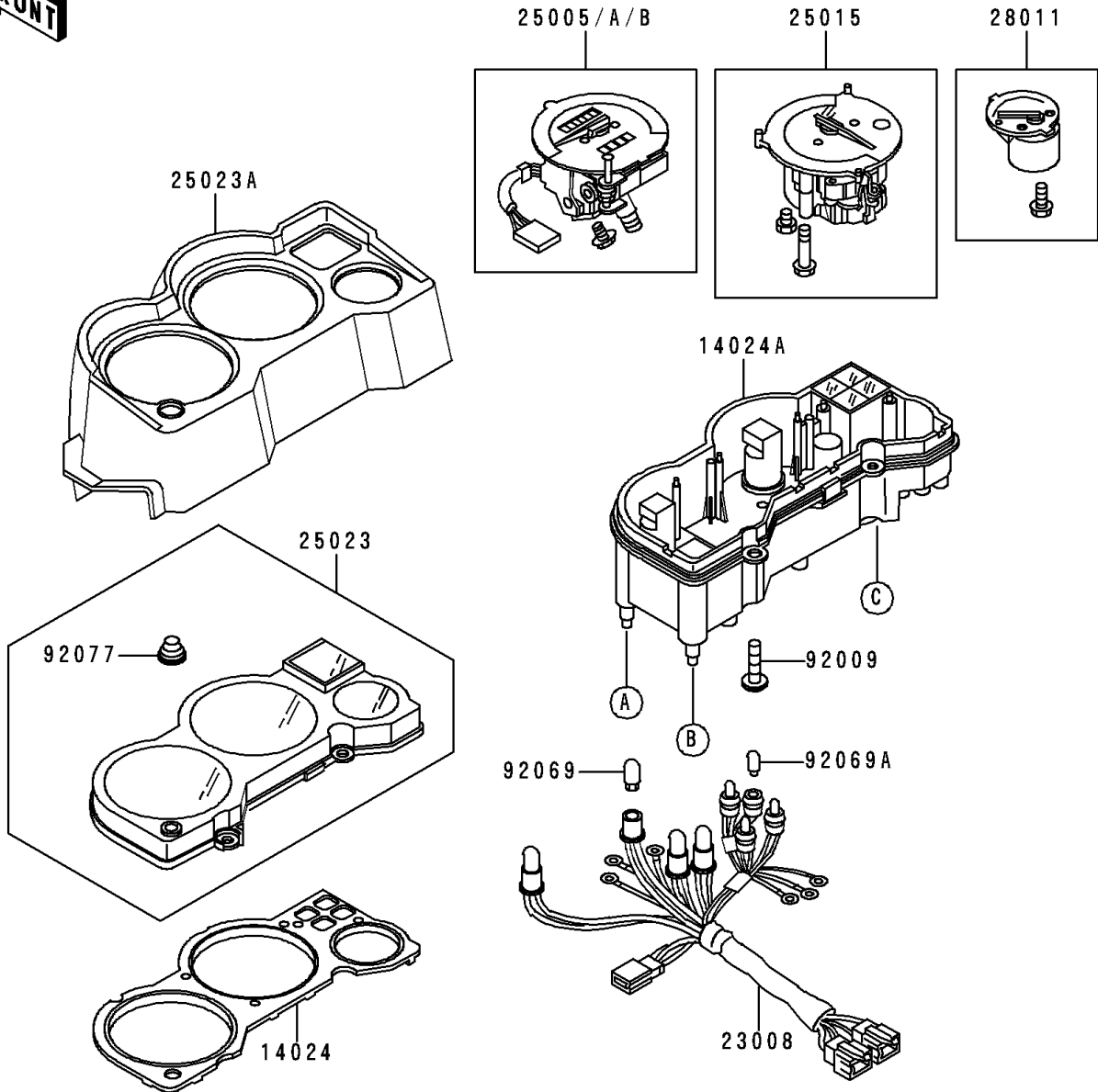









1995 Ninja® 250R PARTS DIAGRAM

Meter(s)

F2530



- | | | |
|---|---|---|
| (A) | (B) | (C) |
|  92075 |  92075 |  92075 |
|  25009 |  25009 |  25009 |
|  92015 |  92015 |  92015 |

1995 Ninja® 250R PARTS LIST

Meter(s)

ITEM NAME	PART NUMBER	QUANTITY
COVER,METER (Ref # 14024)	14024-1463	1
COVER,METER HOUSING (Ref # 14024A)	14024-1664	1
SOCKET-ASSY,METER (Ref # 23008)	23008-1367	1
WASHER,5.2X16X1.2 (Ref # 25009)	25009-004	3
TACHOMETER,X1000R/MIN (Ref # 25015)	25015-1275	1
COVER-METER CASE,UPP (Ref # 25023)	25023-1158	1
COVER-METER CASE (Ref # 25023A)	25023-1159	1
METER,TEMP (Ref # 28011)	28011-1100	1
SCREW,TAPPING,4X16 (Ref # 92009)	92009-1163	4
NUT,FLANGED,5MM (Ref # 92015)	92015-1259	3
BULB,12V 3.4W (Ref # 92069)	92069-1007	3
BULB,12V 3W (Ref # 92069A)	92069-1068	4
DAMPER,METER BRACKET (Ref # 92075)	92075-1385	3
BOOT,TRIP RESET KNOB (Ref # 92077)	92077-1061	1
SPEEDOMETER,KPH (Ref # 25005A)	25005-1379	1
SPEEDOMETER,MPH (Ref # 25005B)	25005-1388	1