

1988 EX500 PARTS DIAGRAM

Taillight(s)

F2720-0249

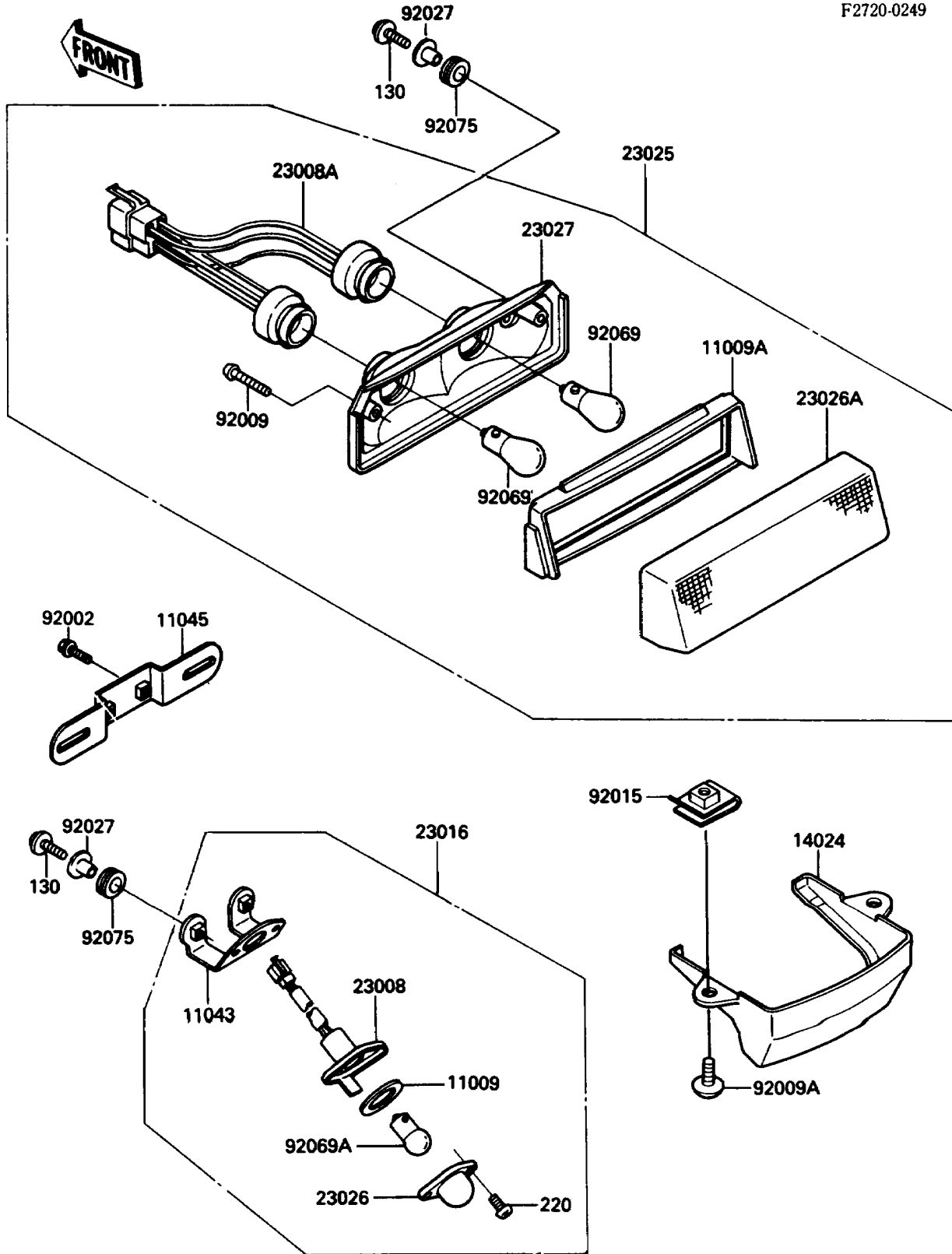

1988 EX500 PARTS LIST

Taillight(s)

ITEM NAME	PART NUMBER	QUANTITY
GASKET,LICENSE PLATE LAMP (Ref # 11009)	11009-1372	1
GASKET,TAIL LAMP (Ref # 11009A)	11009-1404	1
BRACKET,LICENSE PLATE LAMP (Ref # 11043)	11043-1497	1
BRACKET,LICENSE (Ref # 11045)	11045-1387	1
COVER,LICENSE LAMP (Ref # 14024)	14024-1386	1
SOCKET-ASSY,LICENSE PLATE LAMP (Ref # 23008)	23008-1221	1
SOCKET-ASSY,TAIL LAMP (Ref # 23008A)	23008-1225	1
LAMP-ASSY,LICENSE PLATE (Ref # 23016)	23016-1053	1
LAMP-TAIL (Ref # 23025)	23025-1105	1
LENS,LAMP (Ref # 23026)	23026-1054	1
LENS,TAIL LAMP (Ref # 23026A)	23026-1056	1
BODY-COMP-TAIL LAMP (Ref # 23027)	23027-1055	1
BOLT,6X14 (Ref # 92002)	92002-1351	2
SCREW,TAPPING,4X30 (Ref # 92009)	92009-1056	2
SCREW,5X14 (Ref # 92009A)	92009-1383	2
NUT,5MM (Ref # 92015)	92015-1710	2
COLLAR,L=13.1 (Ref # 92027)	92027-251	4
BULB,12V 27/8W (Ref # 92069)	92069-059	2
BULB,12V 8W (Ref # 92069A)	92069-1012	1
DAMPER (Ref # 92075)	92075-1690	4
BOLT-FLANGED,6X25 (Ref # 130)	130D0625	4
SCREW-PAN-CROS (Ref # 220)	220B0410	2