

1993 EX500 PARTS DIAGRAM

Camshafts/Tensioner

E1230

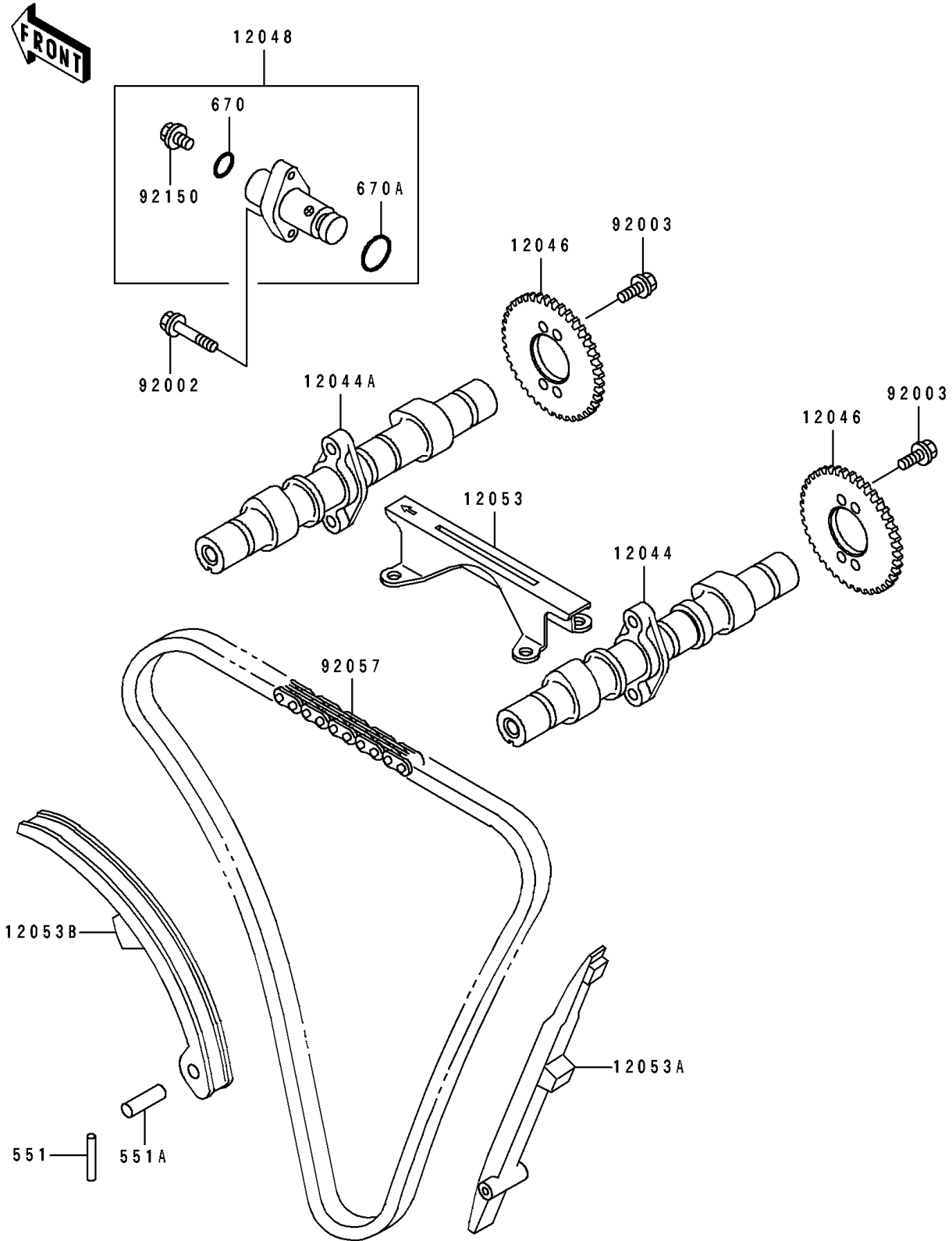

1993 EX500 PARTS LIST

Camshafts/Tensioner

ITEM NAME	PART NUMBER	QUANTITY
CAMSHAFT-VALVE,INTAKE (Ref # 12044)	12044-1198	1
CAMSHAFT-VALVE,EXHAUST (Ref # 12044A)	12044-1199	1
SPROCKET,CAMSHAFT,46T (Ref # 12046)	12046-1075	2
TENSIONER-ASSY,CAM CHAIN (Ref # 12048)	12048-1067	1
GUIDE-CHAIN,UPP (Ref # 12053)	12053-1145	1
GUIDE-CHAIN,RR (Ref # 12053A)	12053-1150	1
GUIDE-CHAIN,FR (Ref # 12053B)	12053-1151	1
BOLT,6X25 (Ref # 92002)	92002-1086	2
BOLT,FLANGED,6X11 (Ref # 92003)	92003-208	4
CHAIN,CAM,79RH2015-148L (Ref # 92057)	92057-1188	1
BOLT,TENSIONER (Ref # 92150)	92150-1380	1
PIN-DOWEL (Ref # 551)	551A0432	1
PIN-DOWEL,8X40 (Ref # 551A)	551A0840	1
O RING (Ref # 670)	670D2010	1
O RING,21MM (Ref # 670A)	670D2021	1