

1993 EX500 PARTS DIAGRAM

Carburetor Parts

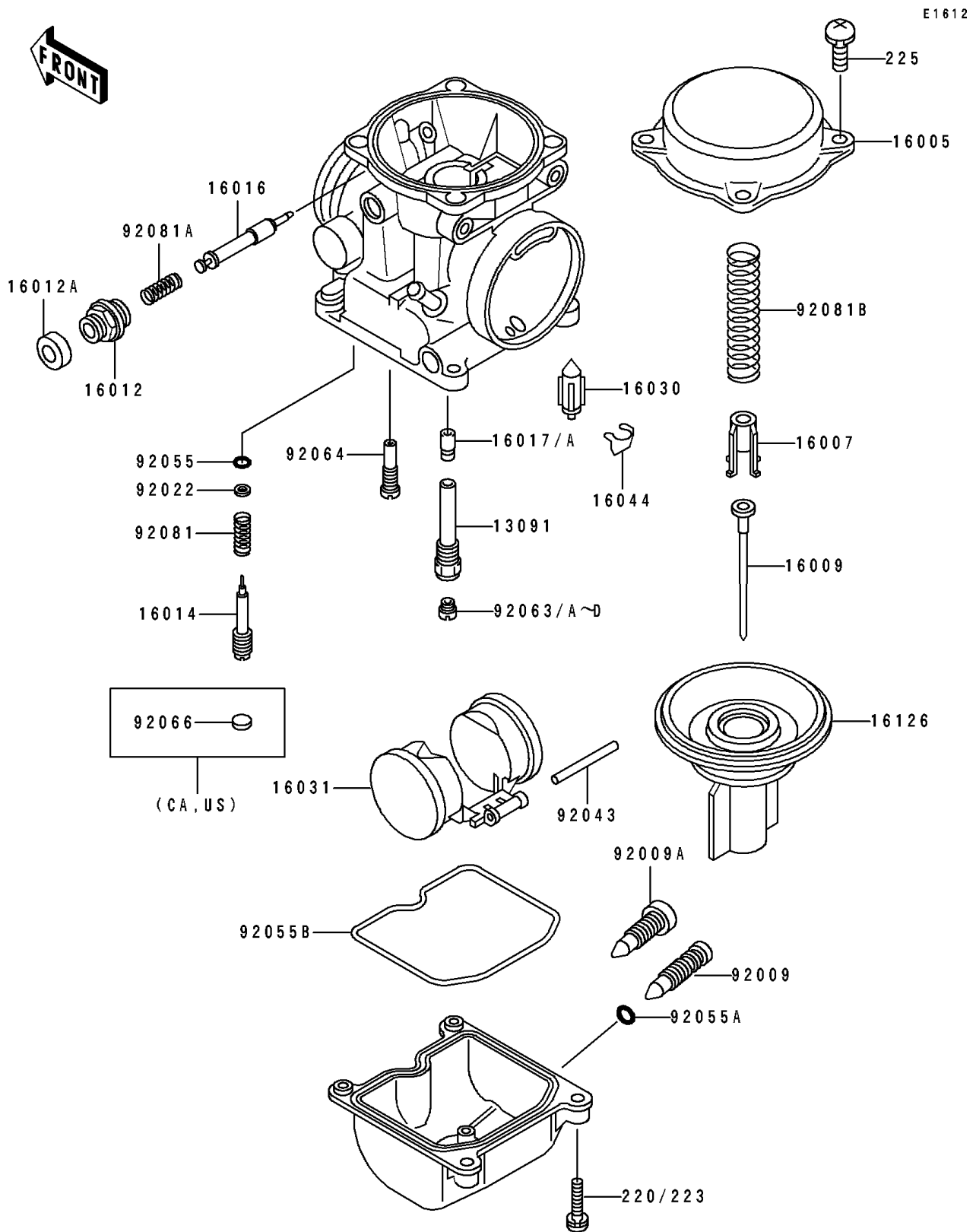

1993 EX500 PARTS LIST

Carburetor Parts

ITEM NAME	PART NUMBER	QUANTITY
HOLDER,NEEDLE JET (Ref # 13091)	13091-1406	2
TOP-CHAMBER,MIXING,27/60 (Ref # 16005)	16005-1057	2
SEAT-SPRING,VALVE (Ref # 16007)	16007-1117	2
NEEDLE-JET,N36N (Ref # 16009)	16009-1342	2
CAP-STARTER PLUNGER (Ref # 16012)	16012-1051	2
CAP-STARTER PLUNGER (Ref # 16012A)	16012-1052	2
SCREW-PILOT AIR (Ref # 16014)	16014-1054	2
PLUNGER,STARTER (Ref # 16016)	16016-1061	2
JET-NEEDLE (Ref # 16017)	16017-1059	2
JET-NEEDLE,#6 (Ref # 16017A)	16017-1208	2
VALVE-FLOAT (Ref # 16030)	16030-1007	2
FLOAT (Ref # 16031)	16031-1056	2
CLAMP,FLOAT VALVE (Ref # 16044)	16044-007	2
VALVE,VACUUM,60PS (Ref # 16126)	16126-1173	2
SCREW,DRAIN,M6X1.0 (Ref # 92009)	92009-1095	2
SCREW,DRAIN,M6X0.75 (Ref # 92009A)	92009-1551	2
WASHER,PLAIN (Ref # 92022)	92022-1003	2
PIN,FLOAT (Ref # 92043)	92043-1207	2
RING-O,PILOT ADJUST (Ref # 92055)	92055-1002	2
RING-O,DRAIN SCREW (Ref # 92055A)	92055-1053	2
RING-O,FLOAT CHAMBER (Ref # 92055B)	92055-1222	2
JET-MAIN,#135 (Ref # 92063)	92063-1014	2
JET-MAIN,2ND,#125 (Ref # 92063A)	92063-1069	2
JET-MAIN,2ND,#128 (Ref # 92063B)	92063-1074	2
JET-MAIN,#130 (Ref # 92063C)	92063-1075	2
JET-MAIN,#132 (Ref # 92063D)	92063-1076	2
JET-PILOT,#35 (Ref # 92064)	92064-1101	2
PLUG,PILOT AIR SCREW,6.9X2 (Ref # 92066)	92066-1051	2
SPRING,PILOT ADJUST SCREW (Ref # 92081)	92081-1002	2

1993 EX500 PARTS LIST

Carburetor Parts

ITEM NAME	PART NUMBER	QUANTITY
SPRING,STARTER PLUNGER (Ref # 92081A)	92081-1761	2
SPRING,VACUUM VALVE (Ref # 92081B)	92081-1874	2
SCREW-PAN-CROS (Ref # 220)	220D0414	8
SCREW-PAN-WS-CROS (Ref # 223)	223C0416	8
SCREW-PAN-WSP-CROS (Ref # 225)	225C0418	7