

1992 EX500 PARTS DIAGRAM

Tires

F2210

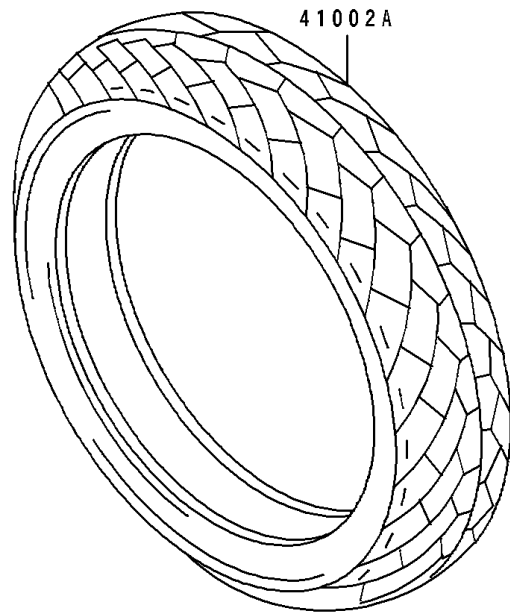
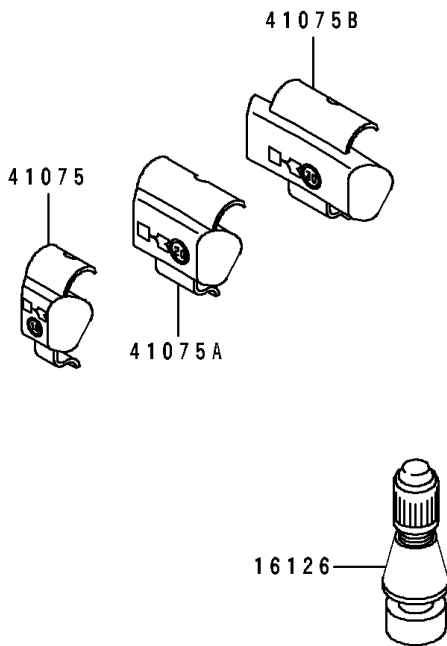
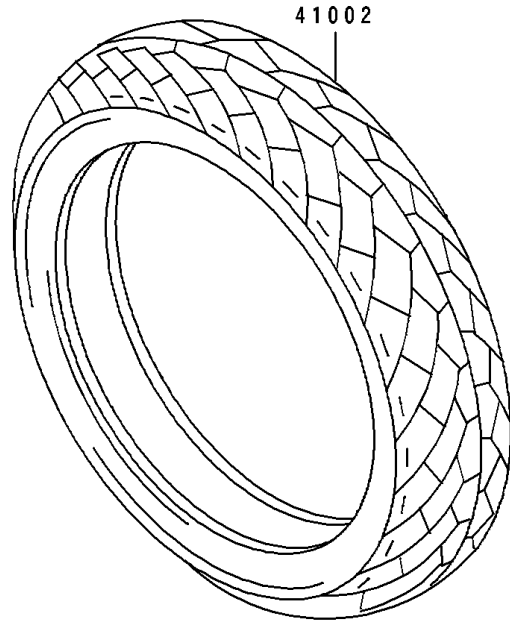
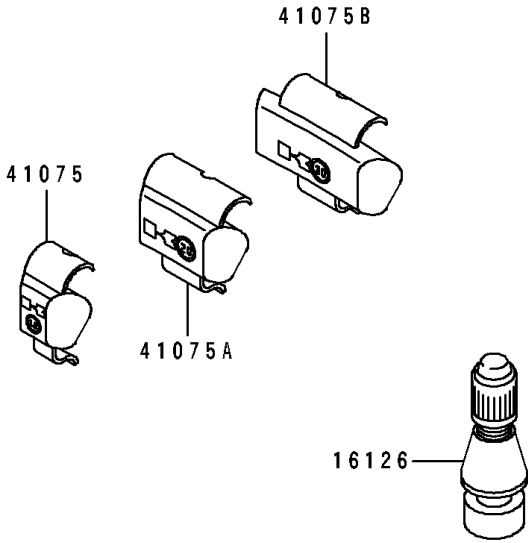

1992 EX500 PARTS LIST

Tires

ITEM NAME	PART NUMBER	QUANTITY
VALVE,TIRE (Ref # 16126)	16126-1140	2
TIRE,FR,100/90-16 54H,G533(BS) (Ref # 41002)	41002-1654	1
TIRE,RR,120/90-16 63H,G534(BS) (Ref # 41002A)	41002-1655	1
BALANCER-WHEEL,10G,SILVER (Ref # 41075)	41075-1014	AR
BALANCER-WHEEL,20G,SILVER (Ref # 41075A)	41075-1015	AR
BALANCER-WHEEL,30G,SILVER (Ref # 41075B)	41075-1016	AR