

# 1993 EX500 PARTS DIAGRAM

Handlebar

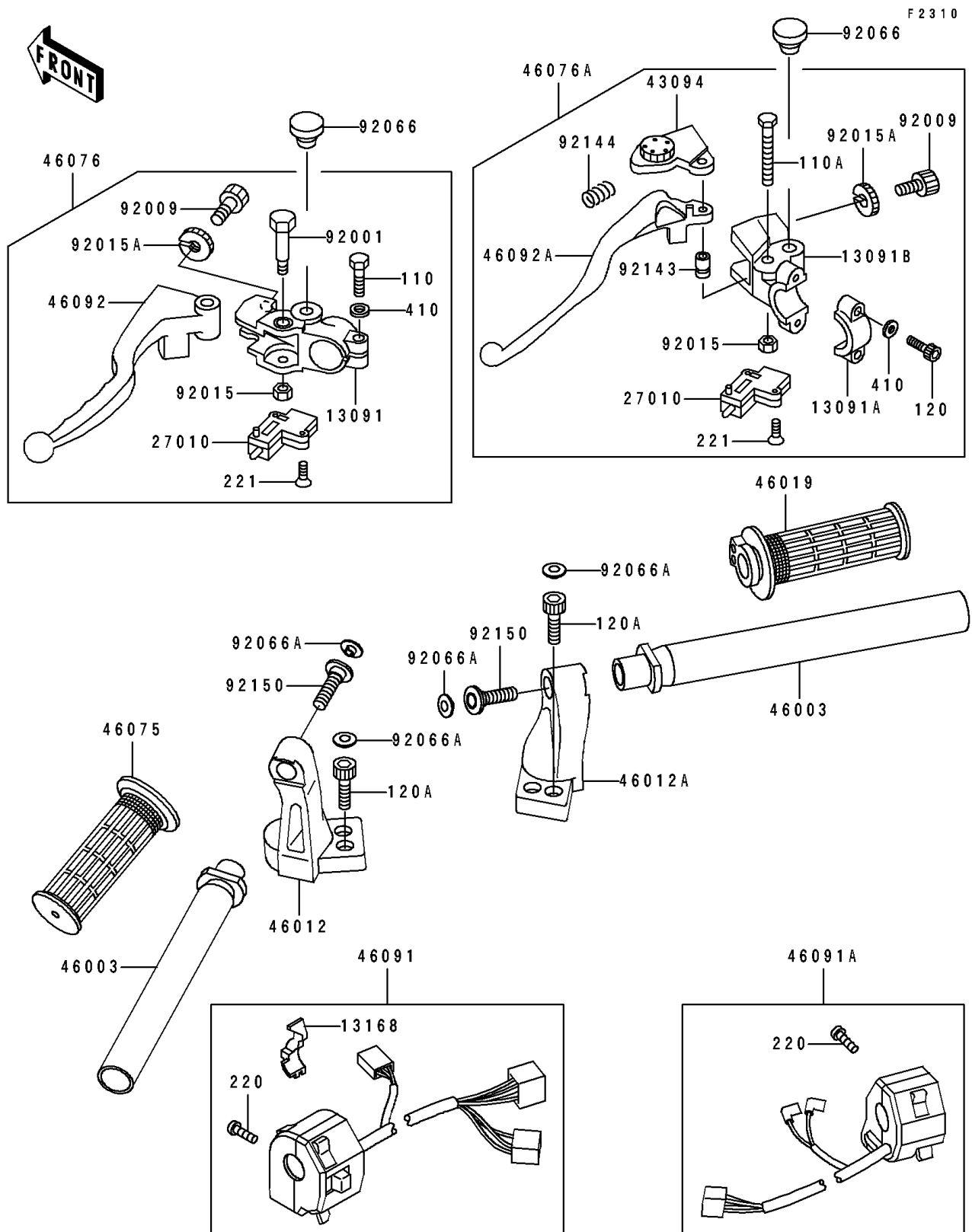

# 1993 EX500 PARTS LIST

## Handlebar

ITEM NAME	PART NUMBER	QUANTITY
HOLDER,CLUTCH LEVER (Ref # 13091A)	13091-1624	1
HOLDER,CLUTCH LEVER (Ref # 13091B)	13091-1652	1
LEVER,CHOKE (Ref # 13168)	13168-1374	1
SWITCH,CLUTCH,BLACK (Ref # 27010)	27010-1094	1
ADJUSTER,CLUTCH LEVER (Ref # 43094)	43094-1053	1
HANDLE (Ref # 46003)	46003-1249	2
HOLDER-HANDLE,LH (Ref # 46012)	46012-1203	1
HOLDER-HANDLE,RH (Ref # 46012A)	46012-1204	1
GRIP-ASSY,THROTTLE (Ref # 46019)	46019-1058	1
GRIP,LH (Ref # 46075)	46075-1022	1
LEVER-ASSY-GRIP,CLUTCH (Ref # 46076A)	46076-1165	1
HOUSING-ASSY-CONTROL,LH (Ref # 46091)	46091-1445	1
HOUSING-ASSY-CONTROL,RH (Ref # 46091A)	46091-1460	1
LEVER-GRIP,CLUTCH (Ref # 46092A)	46092-1161	1
SCREW,CABLE ADJUST,8MM,BLACK (Ref # 92009)	92009-1134	1
NUT,LOCK,6MM,BLACK (Ref # 92015)	92015-1191	1
NUT,CABLE ADJUST LOCK,BLACK (Ref # 92015A)	92015-1197	1
PLUG,9.5X8,POLYETHYLENE (Ref # 92066)	92066-1077	1
PLUG (Ref # 92066A)	92066-1216	6
COLLAR (Ref # 92143)	92143-1379	1
SPRING (Ref # 92144)	92144-1467	1
BOLT,8X30 (Ref # 92150)	92150-1425	2
BOLT,6X40 (Ref # 110A)	110C0640	1
BOLT-SOCKET,6X20 (Ref # 120)	120S0620	2
BOLT-SOCKET (Ref # 120A)	120S0816	4
SCREW-PAN-CROS (Ref # 220)	220C0520	4
SCREW-CSK-CROS (Ref # 221)	221C0316	2
WASHER-PLAIN-SMALL,6MM,BLACK (Ref # 410)	410F0600	2