

1998 Ninja® 500R PARTS DIAGRAM

Crankcase Bolt Pattern

E1412

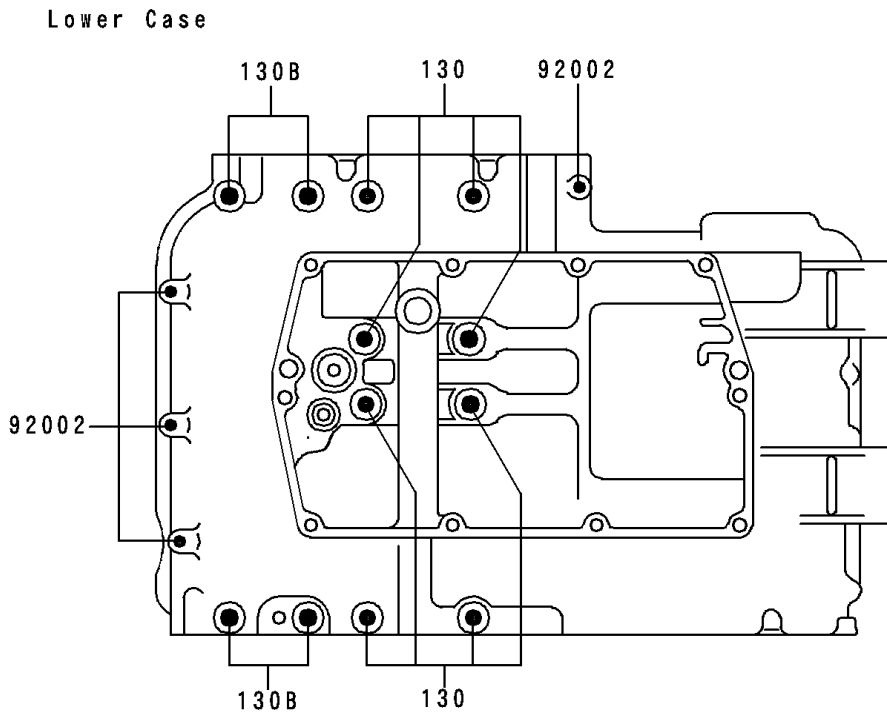
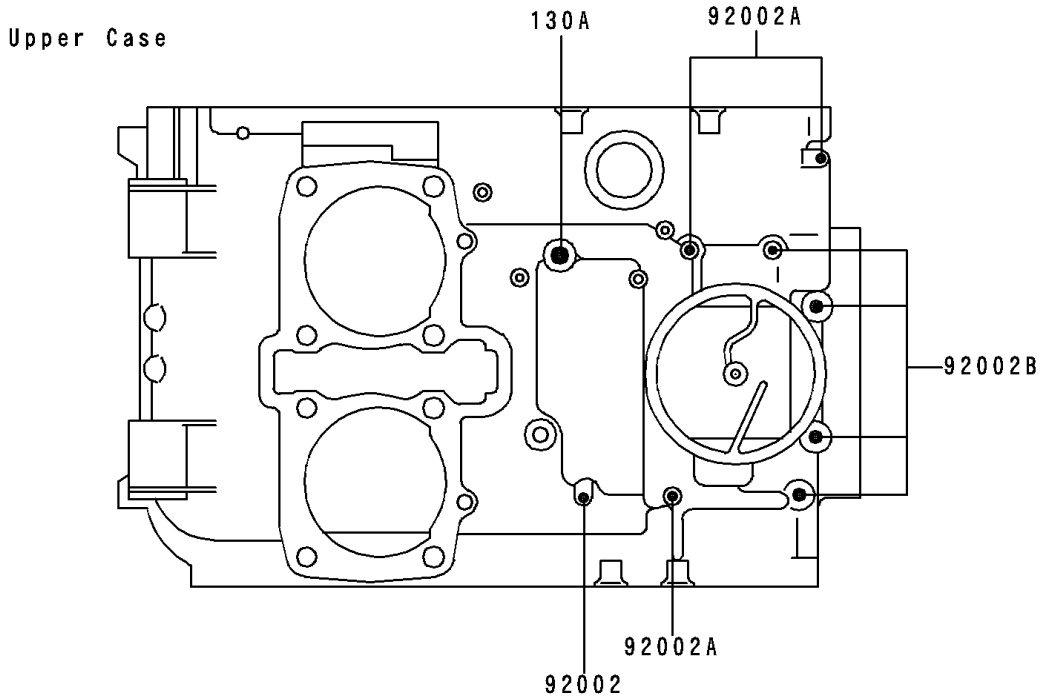

1998 Ninja® 500R PARTS LIST

Crankcase Bolt Pattern

ITEM NAME	PART NUMBER	QUANTITY
BOLT-FLANGED (Ref # 130)	130Z08100	8
BOLT-FLANGED (Ref # 130A)	130Z0855	1
BOLT-FLANGED (Ref # 130B)	130Z0875	4
BOLT,6X40 (Ref # 92002)	92002-1566	5
BOLT,6X60 (Ref # 92002A)	92002-1567	3
BOLT,6X80 (Ref # 92002B)	92002-1568	4