

# 1996 Ninja® 500 PARTS DIAGRAM

Footrests

F2160

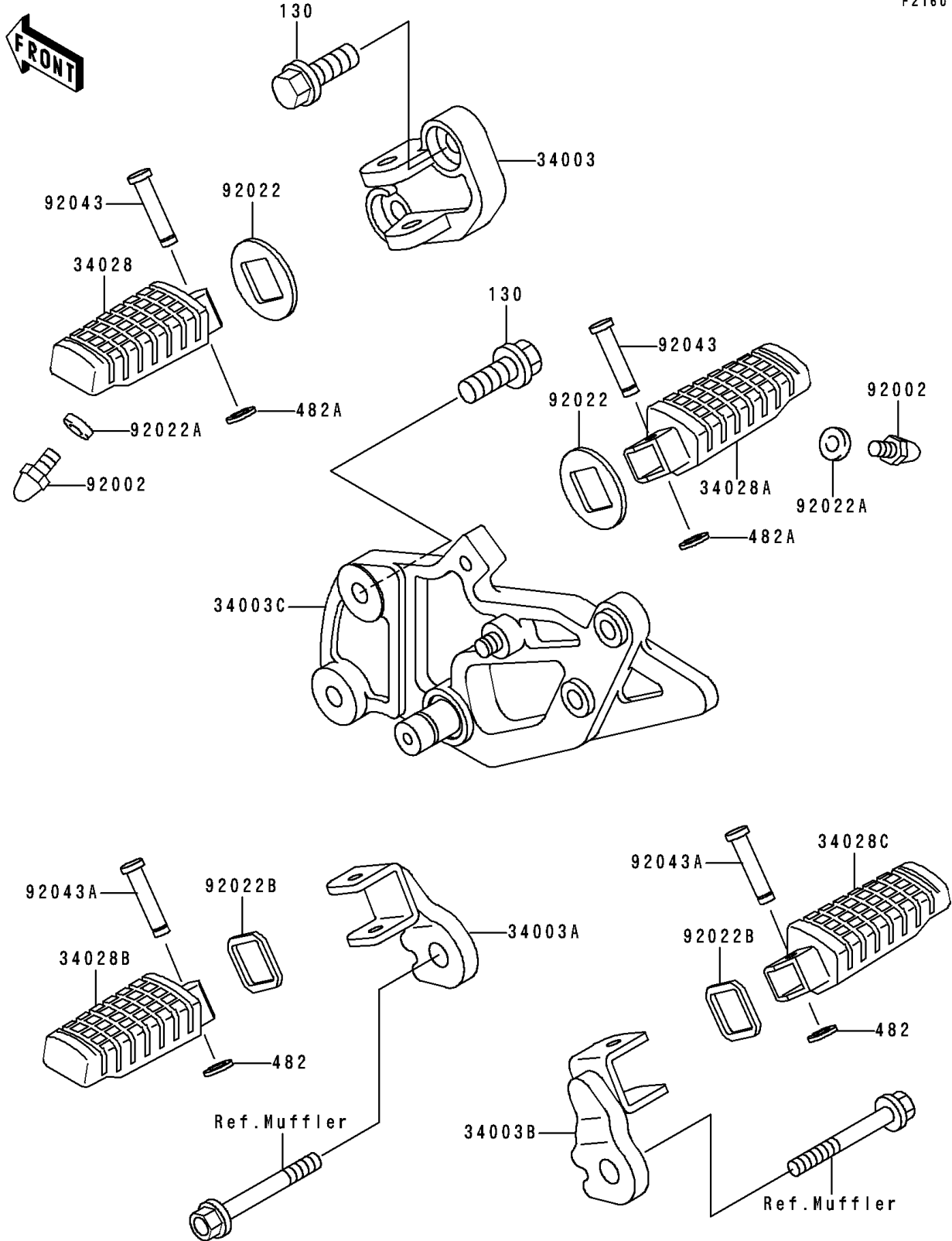

# 1996 Ninja® 500 PARTS LIST

## Footrests

ITEM NAME	PART NUMBER	QUANTITY
BOLT-FLANGED,8X20 (Ref # 130)	130J0820	4
CIRCLIP-TYPE-E,5MM (Ref # 482)	482L5000	2
CIRCLIP-TYPE-E (Ref # 482A)	482L7000	2
HOLDER-STEP,FR,LH (Ref # 34003)	34003-1319	1
HOLDER-STEP,RR,LH (Ref # 34003A)	34003-1321	1
HOLDER-STEP,RR,RH (Ref # 34003B)	34003-1322	1
HOLDER-STEP,FR,RH (Ref # 34003C)	34003-1394	1
STEP,FR,LH (Ref # 34028)	34028-1193	1
STEP,FR,RH (Ref # 34028A)	34028-1194	1
STEP,RR,LH (Ref # 34028B)	34028-1195	1
STEP,RR,RH (Ref # 34028C)	34028-1196	1
BOLT,BANK SENSOR (Ref # 92002)	92002-1995	2
WASHER,STEP FITTING (Ref # 92022)	92022-1314	2
WASHER,6.5X13X2.0 (Ref # 92022A)	92022-1523	2
WASHER,STEP FITTING (Ref # 92022B)	92022-1797	2
PIN,8X40.5 (Ref # 92043)	92043-1326	2
PIN,6X30 (Ref # 92043A)	92043-1327	2