

# 1999 Ninja® 500R PARTS DIAGRAM

Tires

F2210

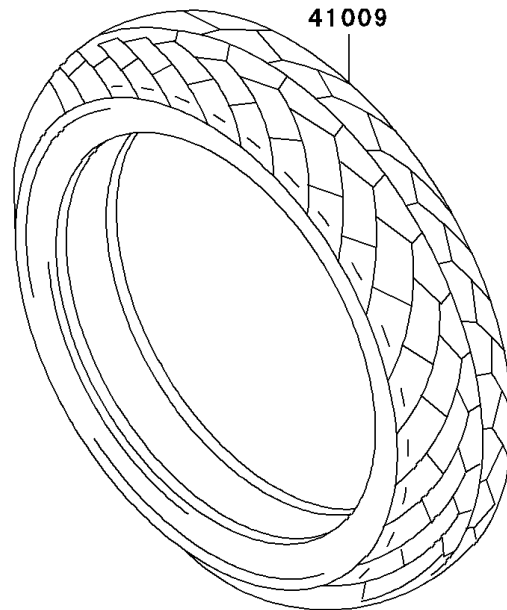
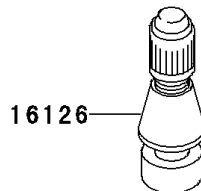
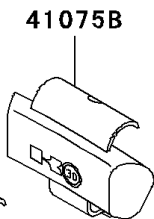
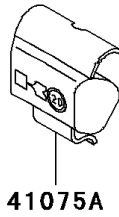
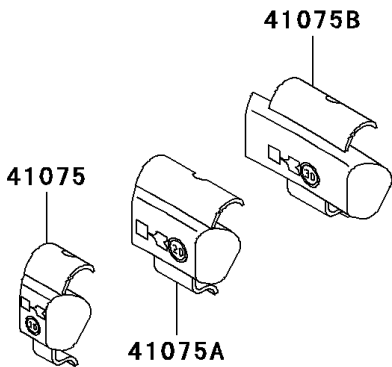
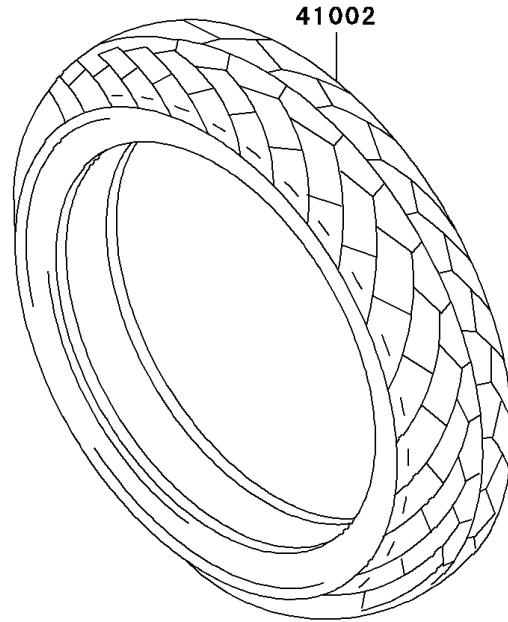
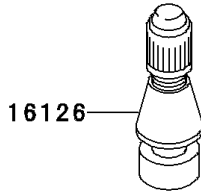
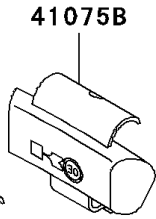
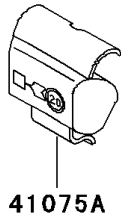
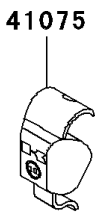

## 1999 Ninja® 500R PARTS LIST

### Tires

ITEM NAME	PART NUMBER	QUANTITY
VALVE,TIRE (Ref # 16126)	16126-1140	2
TIRE,FR,110/70-17 54H,G549(BS) (Ref # 41002)	41002-1981	1
TIRE,RR,130/70-17 62H,G550(BS) (Ref # 41009)	41009-1325	1
BALANCER-WHEEL,10G,SILVER (Ref # 41075)	41075-1014	AR
BALANCER-WHEEL,20G,SILVER (Ref # 41075A)	41075-1015	AR
BALANCER-WHEEL,30G,SILVER (Ref # 41075B)	41075-1016	AR