

2000 Ninja® 500R PARTS DIAGRAM

Brake Pedal/Torque Link

F2260

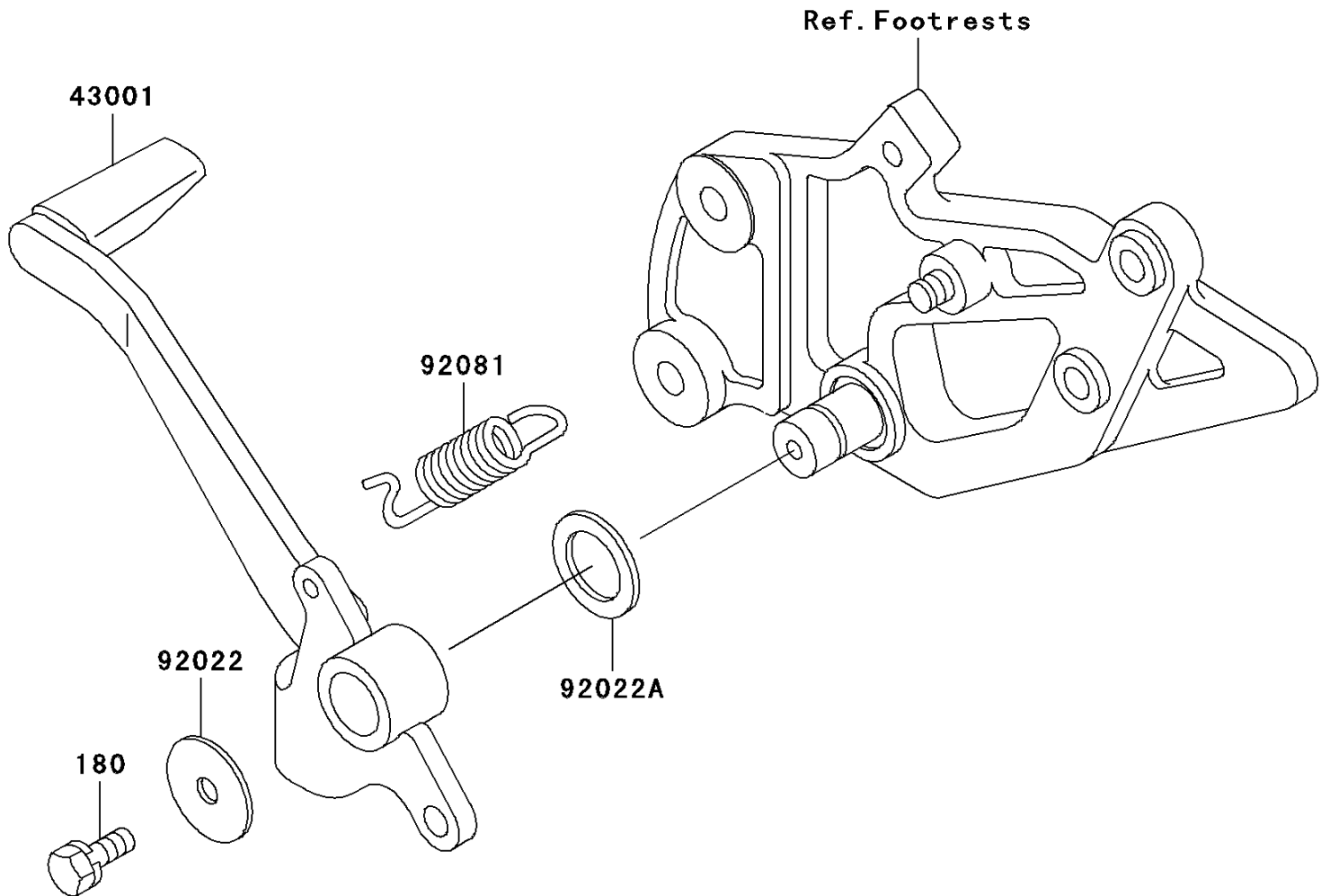

2000 Ninja® 500R PARTS LIST

Brake Pedal/Torque Link

ITEM NAME	PART NUMBER	QUANTITY
BOLT-UPSET-WS (Ref # 180)	180D0616	1
LEVER-BRAKE,PEDAL (Ref # 43001)	43001-1355	1
WASHER,7X28X1.6 (Ref # 92022)	92022-1282	1
WASHER,15.3X24X1 (Ref # 92022A)	92022-326	1
SPRING,BRAKE PEDAL (Ref # 92081)	92081-1833	1