

1990 Jet Mate PARTS DIAGRAM

Oil Pump

(E1710)

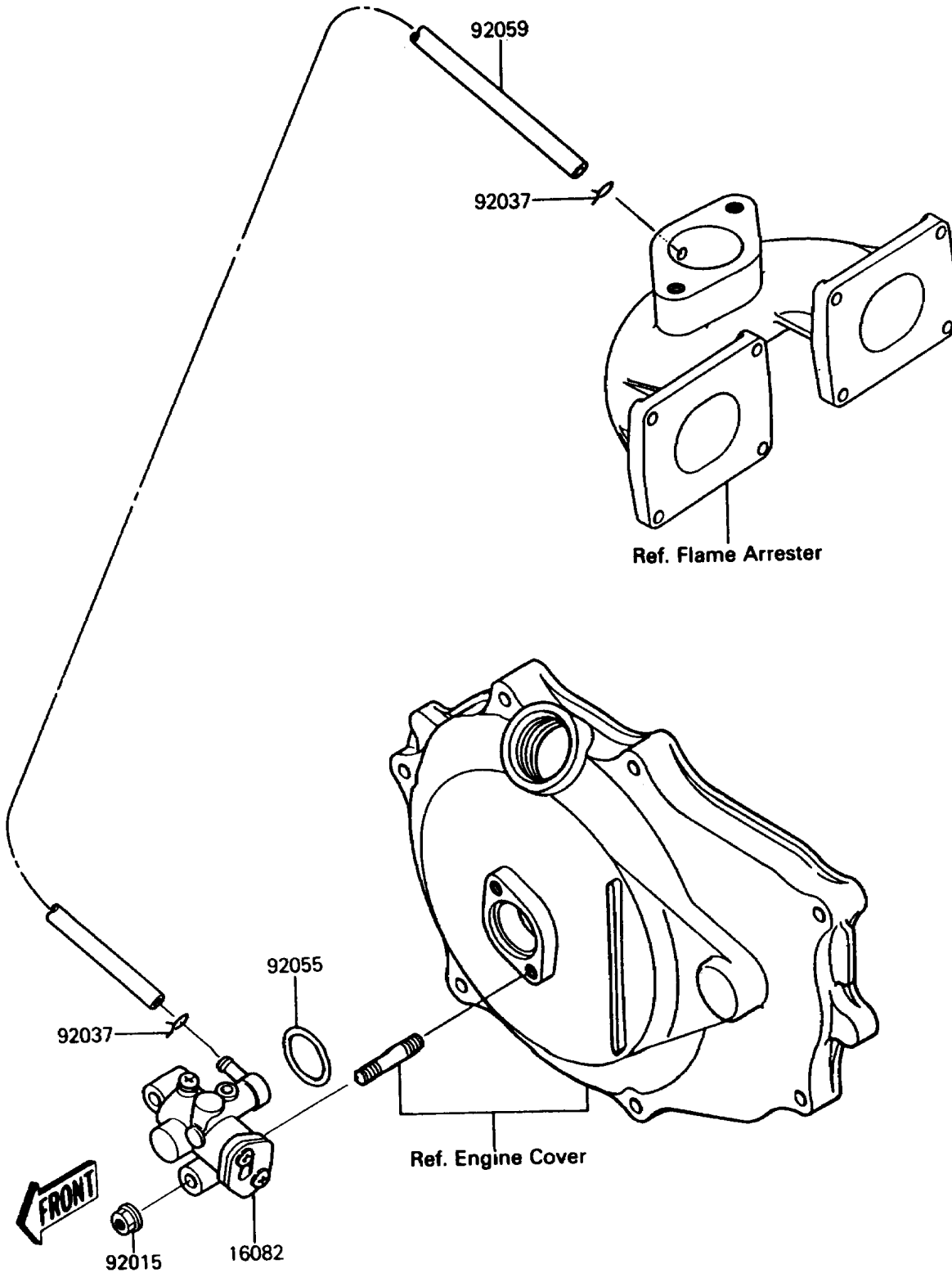

1990 Jet Mate PARTS LIST

Oil Pump

ITEM NAME	PART NUMBER	QUANTITY
PUMP-ASSY-OIL (Ref # 16082)	16082-3710	1
NUT,6MM (Ref # 92015)	92015-3767	2
CLAMP (Ref # 92037)	92037-3722	2
RING-O,19.5X1.5 (Ref # 92055)	92055-055	1
TUBE,3X6X380 (Ref # 92059)	92059-3755	1