

1990 X2 PARTS DIAGRAM

Muffler(s)

E1140

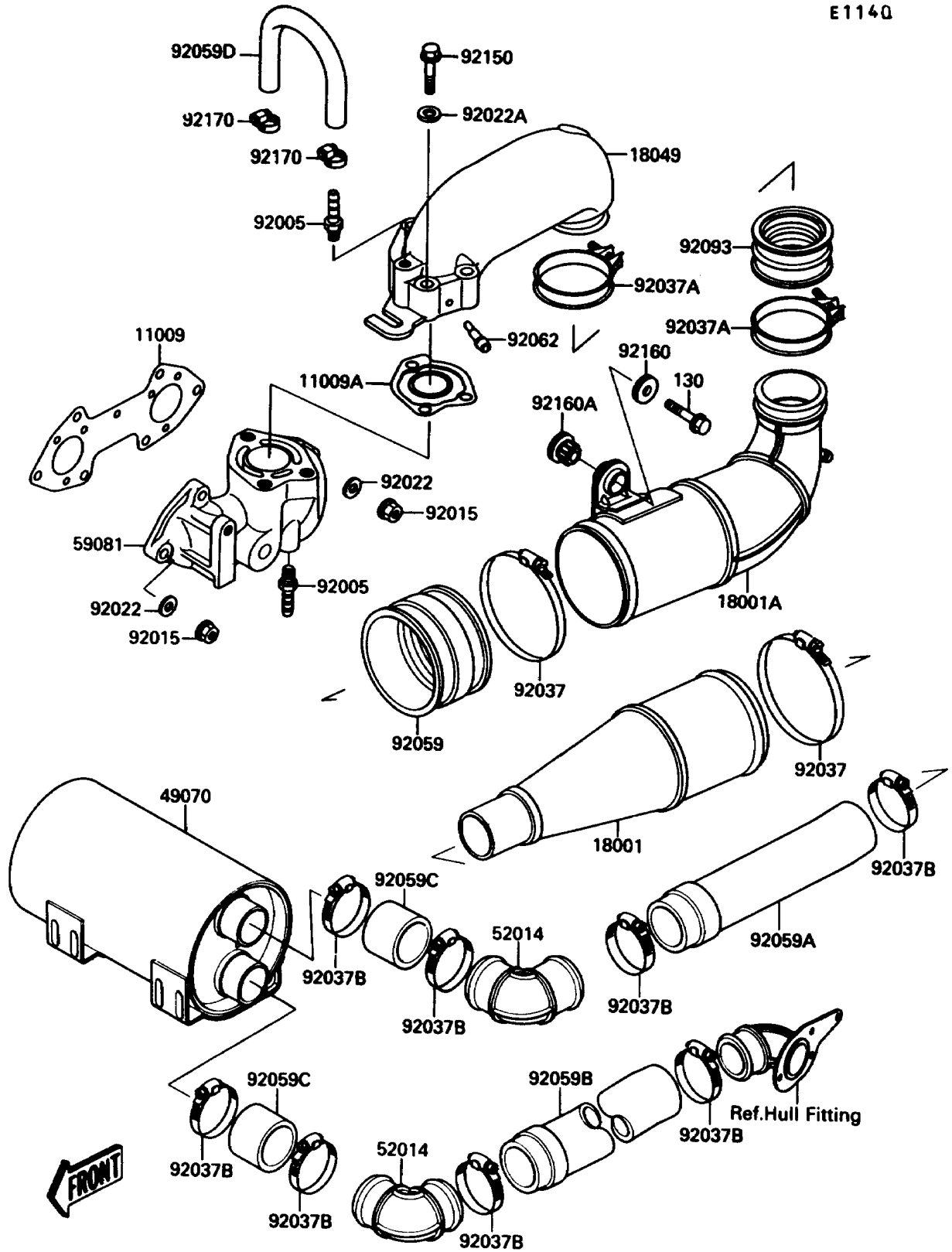

1990 X2 PARTS LIST

Muffler(s)

ITEM NAME	PART NUMBER	QUANTITY
BOLT-FLANGED (Ref # 130)	130Z0845	1
GASKET,EXHAUST MANIFOLD (Ref # 11009)	11009-3722	1
GASKET,EXHAUST PIPE (Ref # 11009A)	11009-3752	1
MUFFLER,BODY (Ref # 18001)	18001-3716	1
MUFFLER (Ref # 18001A)	18001-3720	1
PIPE-EXHAUST (Ref # 18049)	18049-3713	1
MUFFLER-COMP (Ref # 49070)	49070-3711	1
ELBOW (Ref # 52014)	52014-3702	2
MANIFOLD-EXHAUST (Ref # 59081)	59081-3705	1
FITTING,HOSE (Ref # 92005)	92005-3001	2
NUT,8MM (Ref # 92015)	92015-3709	6
WASHER,8.2X18X1.5 (Ref # 92022)	92022-1964	6
WASHER,10.2X20X1.5 (Ref # 92022A)	92022-3742	3
CLAMP,MAX120.7MM (Ref # 92037)	92037-3733	2
CLAMP,68MM (Ref # 92037A)	92037-3740	2
CLAMP (Ref # 92037B)	92037-509	8
TUBE,MUFFLER CONNECTING (Ref # 92059)	92059-3767	1
TUBE (Ref # 92059A)	92059-3805	1
TUBE (Ref # 92059B)	92059-3806	1
TUBE (Ref # 92059C)	92059-3807	2
TUBE (Ref # 92059D)	92059-3816	1
NOZZLE (Ref # 92062)	92062-3705	1
SEAL (Ref # 92093)	92093-3705	1
BOLT,10X50 (Ref # 92150)	92150-3723	3
DAMPER,MUFFLER (Ref # 92160)	92160-3701	1
DAMPER,MUFFLER MOUNT (Ref # 92160A)	92160-3702	1
CLAMP (Ref # 92170)	92170-3718	2