

1990 X2 PARTS DIAGRAM

Engine Hood

F3142

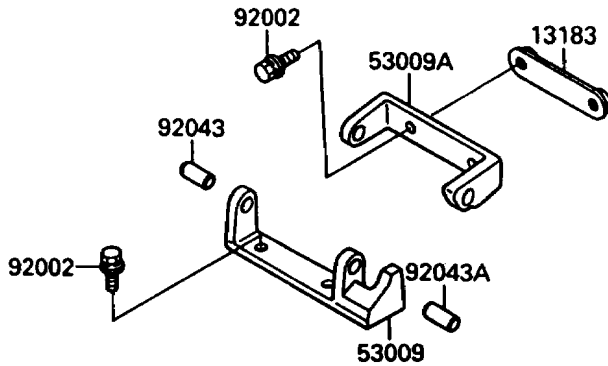
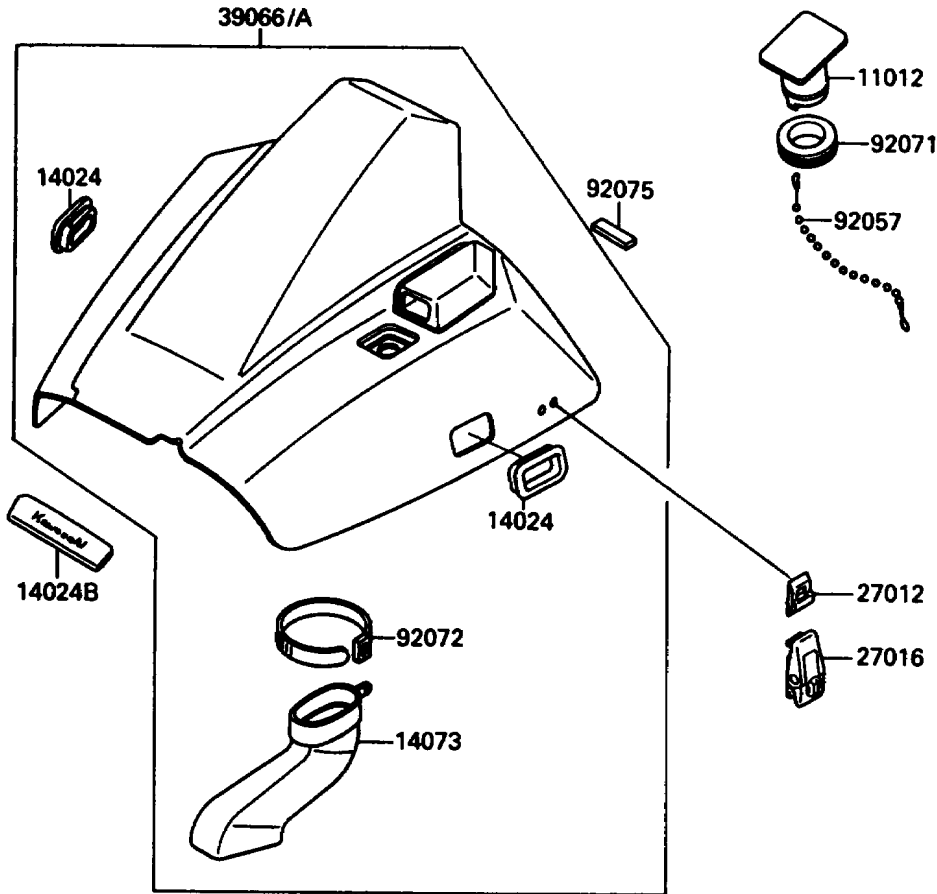

1990 X2 PARTS LIST

Engine Hood

ITEM NAME	PART NUMBER	QUANTITY
CAP,ENGINE HOOD,JET WHITE (Ref # 11012)	11012-3711-8C	2
PLATE (Ref # 13183)	13183-3706	1
COVER,ENGINE HOOD,JET WHITE (Ref # 14024)	14024-3714-8C	2
COVER,ENGINE HOOD,FR (Ref # 14024B)	14024-3740	1
DUCT,ENGINE HOOD (Ref # 14073)	14073-3707	1
HOOK,ENGINE HOOD LOCK (Ref # 27012)	27012-3719	2
LOCK-ASSY,ENGINE HOOD (Ref # 27016)	27016-3706	2
HOOD-ASSY-ENGINE,J.WHITE (Ref # 39066)	39066-3705-8C	1
HINGE,DECK (Ref # 53009)	53009-3703	1
HINGE,ENGINE HOOD (Ref # 53009A)	53009-3704	1
BOLT,8X25 (Ref # 92002)	92002-3774	4
PIN,10X23 (Ref # 92043)	92043-3710	1
PIN,10X25 (Ref # 92043A)	92043-3711	1
CHAIN,COVER,L=250 (Ref # 92057)	92057-3701	2
GROMMET,ENGINE HOOD (Ref # 92071)	92071-3731	2
BAND,L=225 (Ref # 92072)	92072-1174	1
DAMPER (Ref # 92075)	92075-3757	2