

1991 X2 PARTS DIAGRAM

Crankcase

E1411

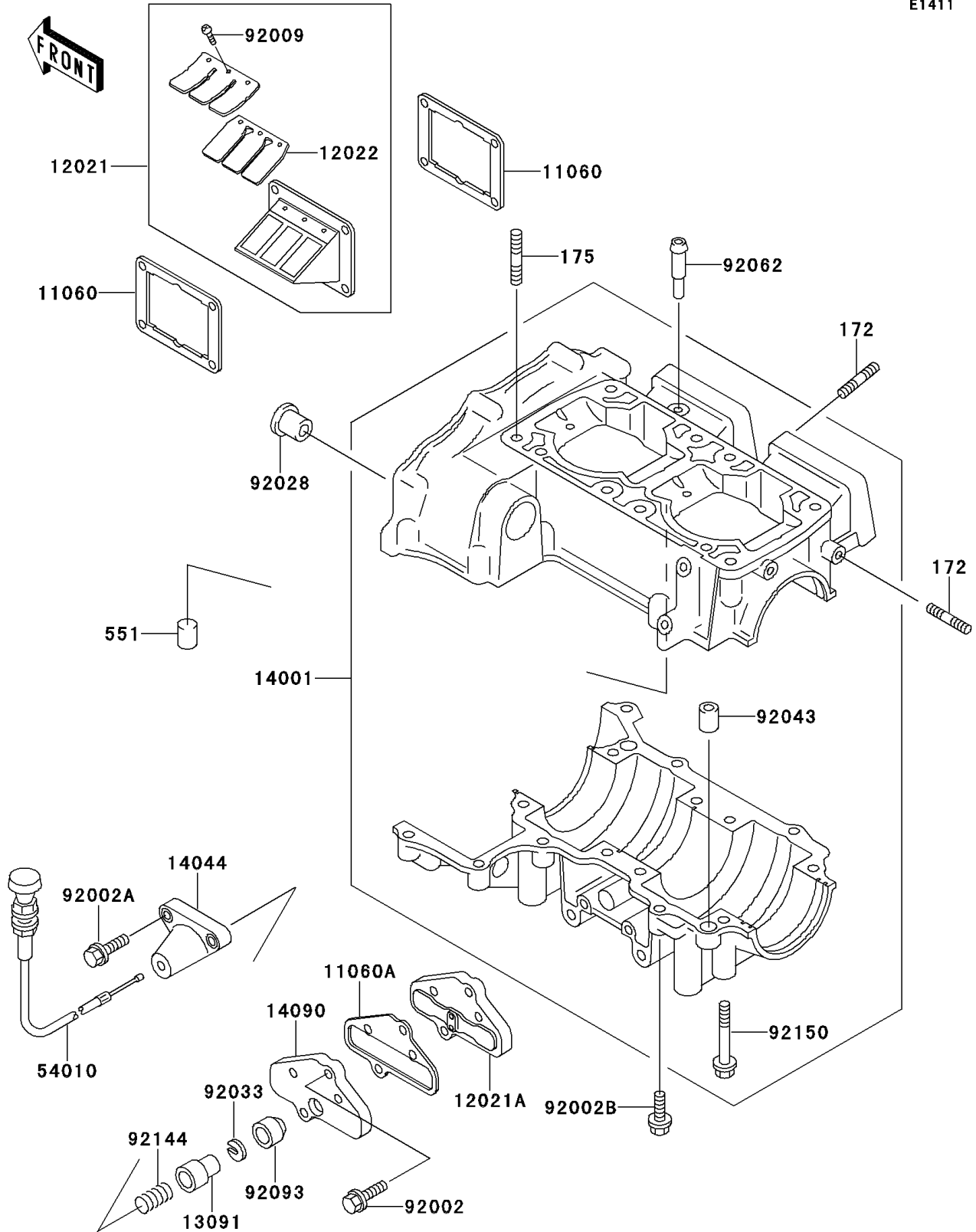

1991 X2 PARTS LIST

Crankcase

ITEM NAME	PART NUMBER	QUANTITY
BOLT-STUD (Ref # 172)	172R0620	10
BOLT-STUD-FINE (Ref # 175)	175R1035	8
PIN-DOWEL (Ref # 551)	551R0612	1
GASKET, REED VALVE (Ref # 11060)	11060-3703	4
GASKET, CONTROL VALVE (Ref # 11060A)	11060-3723	1
VALVE-ASSY-REED (Ref # 12021)	12021-3704	2
VALVE-ASSY-REED, CONTROL (Ref # 12021A)	12021-3707	1
VALVE-REED (Ref # 12022)	12022-1001	4
HOLDER (Ref # 13091)	13091-3707	1
SET-CRANKCASE (Ref # 14001)	14001-5289	1
HOLDER-CABLE (Ref # 14044)	14044-3702	1
COVER, CONTROL VALVE (Ref # 14090)	14090-3734	1
CABLE, CONTROL VALVE (Ref # 54010)	54010-3707	1
BOLT, 6X25 (Ref # 92002)	92002-3714	2
BOLT, 6X45 (Ref # 92002A)	92002-3717	2
BOLT, 6X30 (Ref # 92002B)	92002-3726	7
SCREW, REED VALVE (Ref # 92009)	92009-1014	12
BUSHING (Ref # 92028)	92028-3718	1
RING-SNAP (Ref # 92033)	92033-3708	1
PIN, DOWEL, 10X14 (Ref # 92043)	92043-1037	2
NOZZLE (Ref # 92062)	92062-3705	1
SEAL (Ref # 92093)	92093-3703	1
SPRING (Ref # 92144)	92144-3701	1
BOLT, 8X65 (Ref # 92150)	92150-3708	8