

1993 X2 PARTS DIAGRAM

Ignition System

E1830

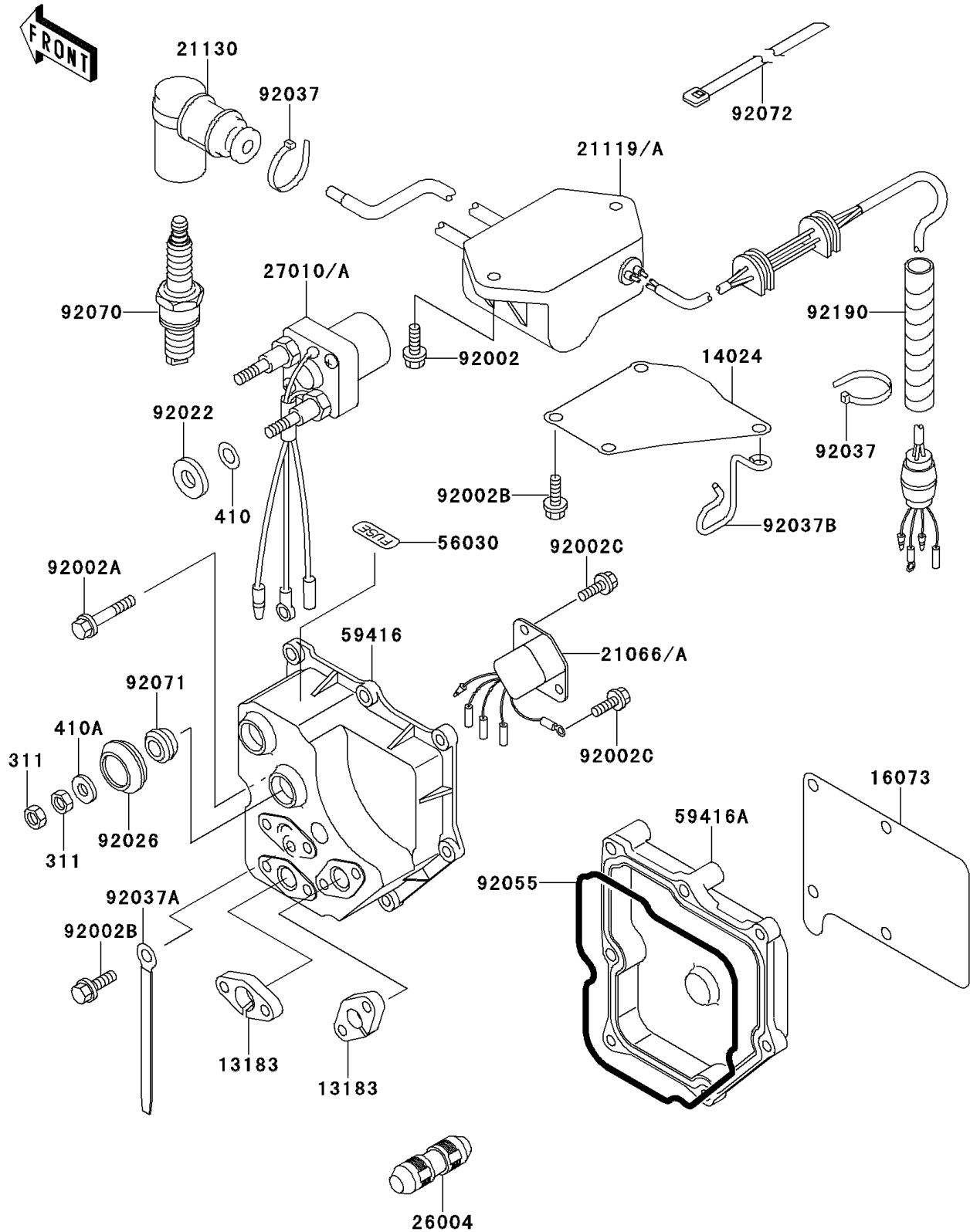

1993 X2 PARTS LIST

Ignition System

ITEM NAME	PART NUMBER	QUANTITY
NUT-HEX,6MM (Ref # 311)	311R0600	4
WASHER-PLAIN-SMALL,10MM (Ref # 410)	410B1000	2
WASHER-PLAIN-SMALL,6MM (Ref # 410A)	410S0600	2
PLATE (Ref # 13183)	13183-3712	3
COVER,VOLTAGE REGULATOR (Ref # 14024)	14024-3799	1
INSULATOR (Ref # 16073)	16073-3703	1
REGULATOR-VOLTAGE (Ref # 21066A)	21066-3708	1
IGNITER (Ref # 21119A)	21119-3725	1
CAP-SPARK PLUG (Ref # 21130)	21130-3706	2
FUSE-ASSY (Ref # 26004)	26004-3711	1
SWITCH,STARTER RELAY (Ref # 27010A)	27010-3724	1
LABEL,FUSE (Ref # 56030)	56030-3792	1
CASE-ELECTRIC (Ref # 59416)	59416-3721	1
CASE-ELECTRIC (Ref # 59416A)	59416-3722	1
BOLT,6X25 (Ref # 92002)	92002-3714	2
BOLT,6X40 (Ref # 92002A)	92002-3716	3
BOLT,6X16 (Ref # 92002B)	92002-3728	14
BOLT,6X12 (Ref # 92002C)	92002-3763	4
WASHER (Ref # 92022)	92022-3035	2
SPACER (Ref # 92026)	92026-3703	2
CLAMP (Ref # 92037)	92037-1173	3
CLAMP,L=100 (Ref # 92037A)	92037-3736	1
CLAMP (Ref # 92037B)	92037-3739	1
RING-O,MAGNETO BASE (Ref # 92055)	92055-1006	1
PLUG-SPARK,BR7ES(NGK) (Ref # 92070)	92070-3701	2
GROMMET (Ref # 92071)	92071-3004	2
BAND,L=188 (Ref # 92072)	92072-1239	1
TUBE,12X15X90 (Ref # 92190)	92190-3805	1