

1990 TS PARTS DIAGRAM

Cylinder Head/Cylinder

E1110

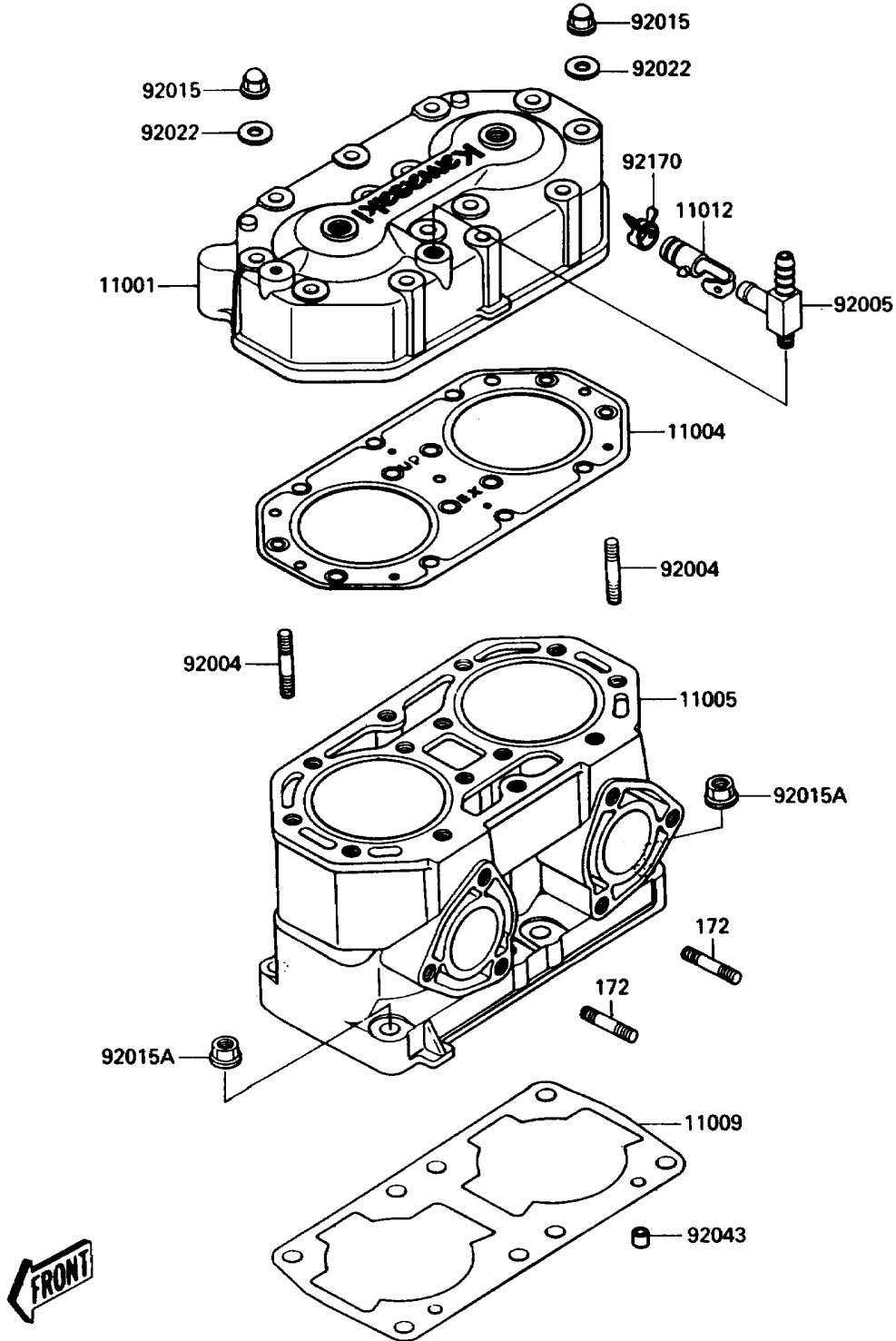

1990 TS PARTS LIST

Cylinder Head/Cylinder

ITEM NAME	PART NUMBER	QUANTITY
HEAD-CYLINDER (Ref # 11001)	11001-3712	1
GASKET-HEAD (Ref # 11004)	11004-3704	1
CYLINDER-ENGINE (Ref # 11005)	11005-3707	1
GASKET,CYLINDER BASE (Ref # 11009)	11009-3719	1
CAP (Ref # 11012)	11012-3744	1
STUD,8X43 (Ref # 92004)	92004-3715	14
FITTING (Ref # 92005)	92005-3704	1
NUT,CAP,8MM (Ref # 92015)	92015-1371	14
NUT,10MM (Ref # 92015A)	92015-3708	8
WASHER,8.2X18X1.5 (Ref # 92022)	92022-1964	14
PIN,DOWEL,6.3X8X14 (Ref # 92043)	92042-007	2
CLAMP (Ref # 92170)	92170-3714	1
BOLT-STUD (Ref # 172)	172R0830	6